

luxury leather collection

BBRACCI
MADE IN ITALY



A WORLD FROM

MAURO BRACCIALE

Starting from here, the work of a lifetime, to imagine a new future.

This is what Mauro Bracciale has done, now owner of Bracci and for more than 30 years in the leather upholstery business, managing important Italian sofa manufacturers.

Bracci was established in 2012 with the idea to bring to the North American market a collection designed and made in Italy. But not only !...Bracci sofas are specially designed to have a remarkable US personality, meaning that product development is done in Italy with only the North America market in mind.

Mauro Bracciale's great propensity to research new ideas, of style and customization, throughout the years has put together a great selection of products in all categories: stationary, power motion, power recliners, occasional chairs and sofa beds.

Bracci is a brand that means design, craftsmanship and Italianity, a brand strongly thought and wanted by its founder, a brand that could not fail to inherit from him passion and authenticity.

BRACCI
MADE IN ITALY

WE FURNISH THE MOST BEAUTIFUL HOMES IN AMERICA



Bracci brings timeless Italian designs into American Homes. This is what Bracci does with a luxury collection of leather sofas “Made in Italy” able to accommodate in the same living area, the idea of American comfort and Italian design.

This is how the soft aesthetics of Bracci sofas are born, supported by backrests and armrests with rigid lines and capable of telling, sofa after sofa, a story of balanced lightness. An anthem of visual comfort shows in the entire collection and it fits harmoniously in the living area to respond to the contemporary needs of the North American market. The prestigious coverings and décor stitchings emphasize the flowing lines along the profiles without interrupting the generous volumes.

Bracci is commitment to the highest level of craftsmanship, product is made only with premium hides of European origin, cut by hand using traditional techniques, that cannot be substituted with modern cutting technology, along with eco-friendly foam, wood and other materials that meet the highest standards in the industry.

Our timeless Italian-American designs never go out of style and we furnish the most beautiful homes in North America.

Design, comfort and style is a special Italian vocation to beauty. This is Bracci.

Thank you for taking the time to review our Collection.

BRACCI
MADE IN ITALY

PRODUCT INDEX

Pag. 9

STATIONARY SOFAS
& SECTIONAL

Pag. 135

POWER MOTION SOFAS
& SECTIONAL

Pag. 253

SOFA BEDS

Pag. 287

POWER RECLINERS

Pag. 297

OCCASIONAL CHAIRS

Pag. 309

PILLOWS

BBRACCI
MADE IN ITALY



Pag. 10
ARTU'



Pag. 50
FLOW



Pag. 18
BRERA



Pag. 56
GLAMOUR



Pag. 24
CHIC



Pag. 64
GOSH



Pag. 86
LIVING



Pag. 116
TAORMINA



Pag. 32
DANTE



Pag. 70
GROW



Pag. 94
MOREA



Pag. 122
TIVOLI



Pag. 38
DISCOVERY



Pag. 76
ICARO



Pag. 100
NARCISO



Pag. 128
TRENDY



Pag. 44
FELLINI



Pag. 82
KARMA



Pag. 106
PLANE

STATIONARY SOFAS & SECTIONAL

Create a sofa that embraces everyone, perfectly adapting to the space. This is how Bracci furnishes contemporary spaces with many solutions that never leave style behind.

With mini small and maxi configurations to fill large spaces, our sofas allow you to increase both seating and comfort at the same time.

And if you choose the ottoman solution, you will have yet another soft moment to relax your legs and ideas.

Artù

Wide armrests, a square design, rounded corners, cozy seating.
Every inch of this sofa speaks of comfort.



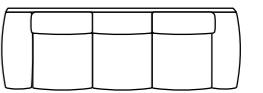

V342 W122"

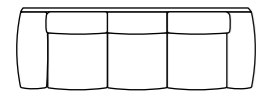

V342 W122"



Artù

Artù' is distinguished by its welcoming deep seats, offering long moments of relaxation in the company of family and friends. The detailed trapezoid-shaped base offers the structure a sense of lightness.





Artù

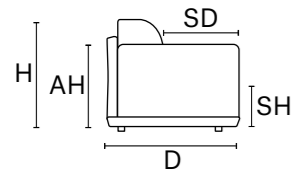

D 41" | H 35" | AH 23" | SH 18" | SD 22"

Artù

MAXI SEAT (version of the group have the same seat width)

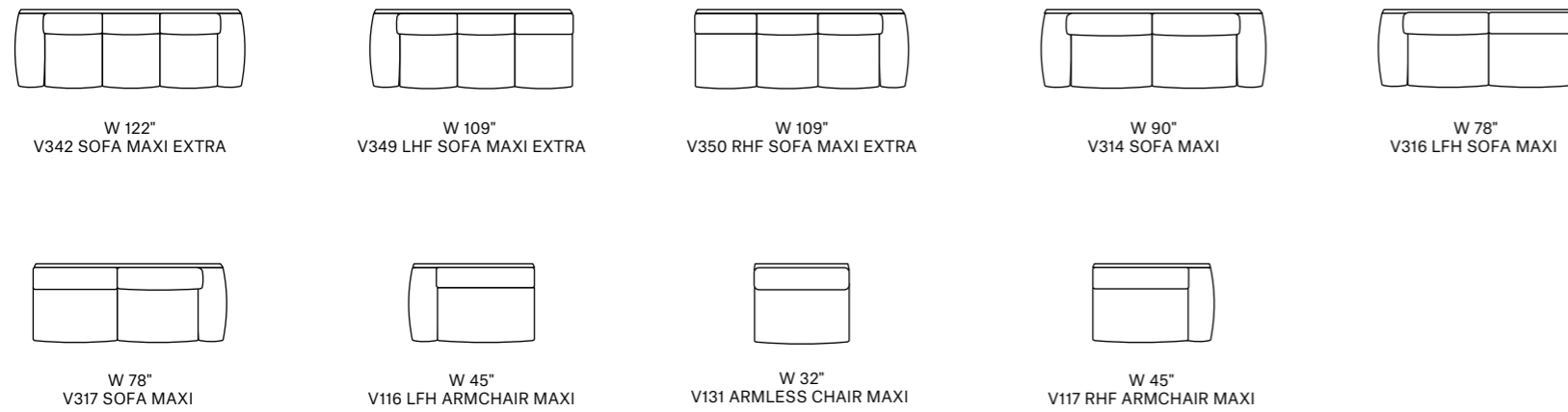

MEDIUM SEAT (version of the group have the same seat width)

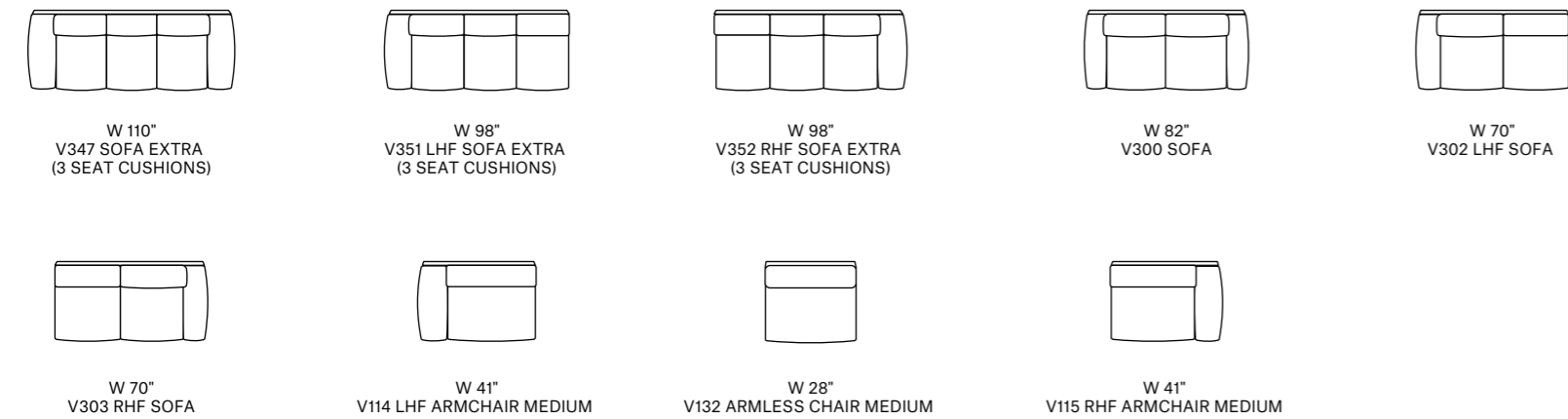

SMALL SEAT (version of the group have the same seat width)

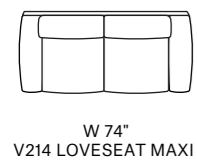

JOLLY (can be combined with all the version group)

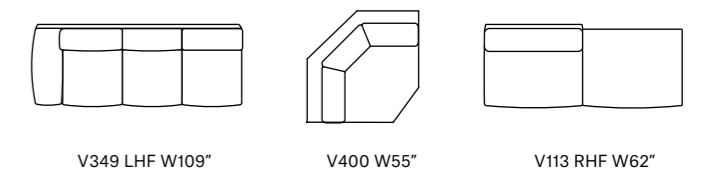
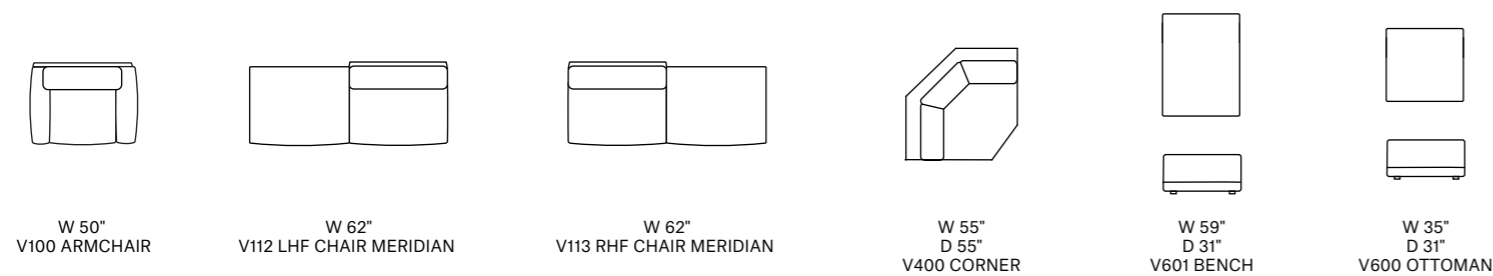

Thin stitch standard

Thick stitch option



Artù

Technical Description

- thick stitch:** Available as option
- structure:** Hardwood frame for extra strength
- seat/back suspension:** Reinforced elastic webbing
- seat/back cushions:** High density ecologic open cell polyurethane foam covered with a layer of dacron wadding
- removability:** Back cushions
- mechanisms:** N.A.
- foot:** Not visible

LEATHER COLOR SHADE DIFFERENCES: The model upholstered with some Natural leather such as Maya, Moss, Carees and Sensation, could present in some area differences in color tones of about 5%. Such differences are not to be considered defect but an expression of the natural characteristic of the cowhide. The company reserves the right without prior notice to make technical sheets changes and/or materials for quality product improvement. Leather sofas are a handmade product and according to the leather covering selected there could be a measurement tolerance of about 2 inches (cm 5) on each sku.
 REV. 002 DEL 28/10/2020 | Pag. 2 of 2

Brera

Its natural elegance and sophistication acquires extra grit with the addition of the end element and even more seating.



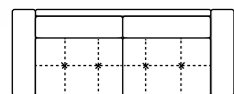

V314 W92"

Brera

Brera becomes the protagonist of living spaces because it is characterized by essential lines and modern design. In addition, the seat and back filled with the right combination of memory foam offers an extreme soft seating comfort which perfectly adapts to the body.

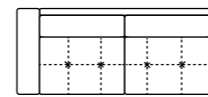

V316 LHF W82"

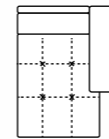

V501 RHF W46"

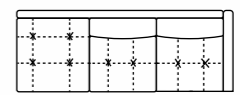

V406 LHF W100"

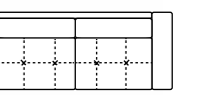

V317 RHF W82"

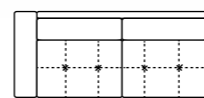

V316 LHF W82"

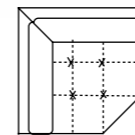

V400 W54"

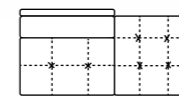

V113 RHF W61"

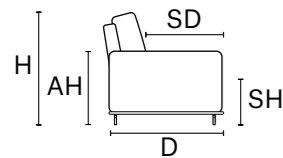

D 40" H 33" AH 22" SH 18" SD 22"

MAXI SEAT (version of the group have the same seat width)

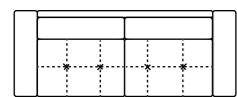

W 92"
V314 SOFA MAXI

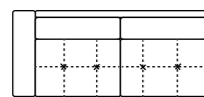

W 82"
V316 LHF SOFA MAXI

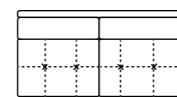

W 72"
V315 SOFA MAXI ARMLESS

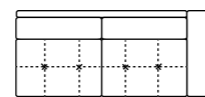

W 82"
V317 RHF SOFA MAXI

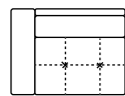

W 46"
V 116 LHF ARMCHAIR MAXI

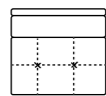

W 36"
V 131 ARMLESS CHAIR MAXI

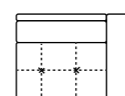

W 46"
V 117 RHF ARMCHAIR MAXI

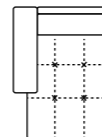

W 46"
D 66"
V 500 LHF CHAISE LONGUE

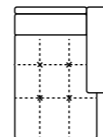

W 46"
D 66"
V 501 RHF CHAISE LONGUE

MEDIUM SEAT (version of the group have the same seat width)

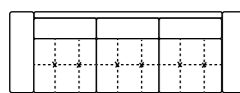

W 116"
V347 SOFA EXTRA (3 CUSHIONS)

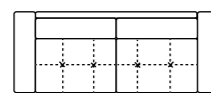

W 84"
V300 SOFA

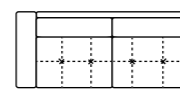

W 74"
V302 LHF SOFA

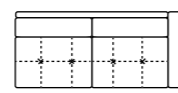

W 74"
V303 RHF SOFA

SMAL SEAT (version of the group have the same seat width)

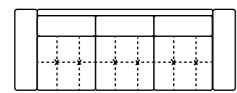

W 103"
V242 LOVESEAT MAXI EXTRA

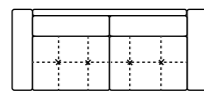

W 76"
V214 LOVESEAT MAXI

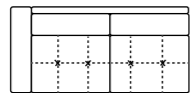

W 66"
V216 LHF LOVESEAT MAXI

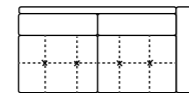

W 66"
V217 RHF LOVESEAT MAXI

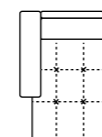

W 38"
D 66"
V 504 LHF CHAISE LONGUE MINI

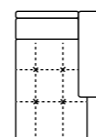

W 38"
D 66"
V 505 RHF CHAISE LONGUE MINI

JOLLY (can be combined with all the version group)

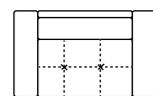

W 45"
V 100 ARMCHAIR

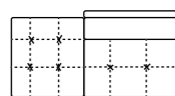

W 61"
V 112 LHF CHAIR MERIDIAN

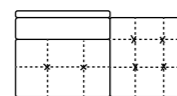

W 61"
V 113 RHF CHAIR MERIDIAN

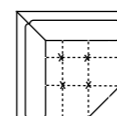

W 54"
D 54"
V 400 CORNER

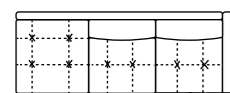

W 100"
V 406 LHF CORNER CHAIR MERIDIAN

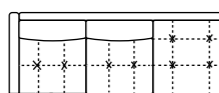

W 100"
V 407 RHF CORNER CHAIR MERIDIAN



W 35"
D 24"
V 600 OTTOMAN



W 35"
D 35"
V 601 BENCH

Brera

Technical Description

thick stitch: Available as option

structure: Hardwood frame with metal insert for extra strength

seat/back suspension: Reinforced elastic webbing

seat cushion: High density ecologic open-cell polyurethane foam and memory foam covered with a layer of dacron wadding

back cushion: High density ecologic open-cell polyurethane foam covered with a layer of dacron wadding

removability: seat/back cushion

mechanism: N.A.

foot option # 1: Stainless steel finish

foot option # 2: Stainless steel bronze Finish

Foot Finishing Option



Foot Option 1:
Stainless Steel Finish



Foot Option 2:
Stainless Steel Bronze Finish

Thin stitch standard



Thick stitch option



LEATHER COLOR SHADE DIFFERENCES: The model upholstered with some Natural leather such as Maya, Moss, Carees and Sensation, could present in some area differences in color tones of about 5%. Such differences are not to be considered defect but an expression of the natural characteristic of the cowhide. The company reserves the right without prior notice to make technical sheets changes and/or materials for quality product improvement. Leather sofas are a handmade product and according to the leather covering selected there could be a measurement tolerance of about 2 inches (cm 5) on each sku.

REV. 002 DEL 28/10/2020 | Pag. 2 of 2

Chic

Available in different finishes and therefore able to adapt to different styles, this sofa has a steel structure to support a softness completely covered in leather. Textured.



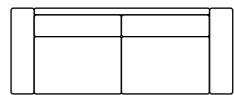

V314 W93"

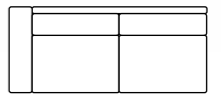

V316 LHF W81"

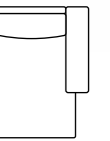

V501 RHF W43"

Chic

Chic is the result of a perfect balance between an elegant straight line design and minimalist taste. The extreme seating comfort is offered by seats and backs filled with the right combination of feather down.

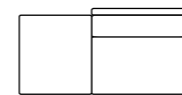

V112 LHF W61"

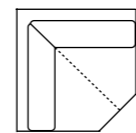

V400 W54"

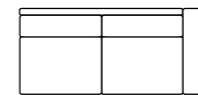

V317 RHF W81"

Chic



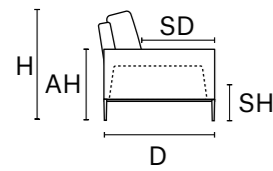

D 41" H 33" AH 24" SH 18" SD 21

STANDARD

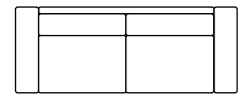

W 93"
V 314 SOFA MAXI

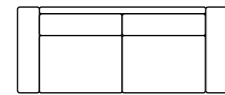

W 85"
V 300 SOFA

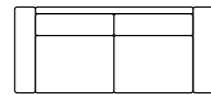

W 78"
V 214 LOVESEAT MAXI



W 81"
V 316 LHF SOFA MAXI

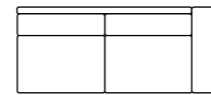

W 81"
V 317 RHF SOFA MAXI

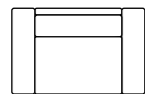

W 38"
V100 ARMCHAIR

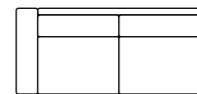

W 73"
V302 LHF SOFA

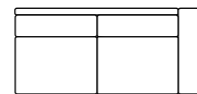

W 73"
V303 RHF SOFA

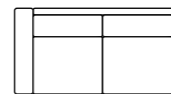

W 66"
V216 LHF LOVESEAT MAXI

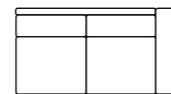

W 66"
V217 RHF LOVESEAT MAXI

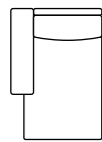

W 43"
D 67"
V500 LHF CHAISE LONGUE

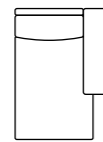

W 43"
D 67"
V501 RHF CHAISE LONGUE

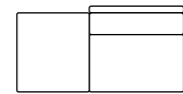

W 61"
V112 LHF CHAIR MERIDIAN

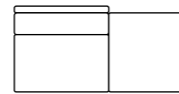

W 61"
V113 RHF CHAIR MERIDIAN

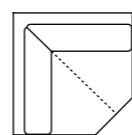

W 54"
D 54"
V400 CORNER

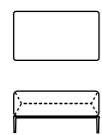

W 37"
D 28"
V600 OTTOMAN

Chic

Technical Description

thick stitch: Available

structure: Stainless steel frame combined with hard wood frame for extra strength

seat/back suspension: Reinforced elastic webbing

seat / back cushion: High density ecologic open-cell polyurethane foam, pocket spring, and duck feathers covered with a layer of dacron wadding

removability: Seat and back cushions

mechanism: N.A.

foot/base series: Stainless steel finish base , Base stainless steel matt bronze, Base stainless steel matt black

covering: Full leather

Foot Finishing Option



Foot Option 1:
Stainless Steel Finish Base



Foot Option 2:
Base stainless steel matt bronze



Foot Option 3:
Base stainless steel matt black



Thin stitch standard



Thick stitch option



LEATHER COLOR SHADE DIFFERENCES: The model upholstered with some Natural leather such as Maya, Moss, Carees and Sensation, could present in some area differences in color tones of about 5%. Such differences are not to be considered defect but an expression of the natural characteristic of the cowhide. The company reserves the right without prior notice to make technical sheets changes and/or materials for quality product improvement. Leather sofas are a handmade product and according to the leather covering selected there could be a measurement tolerance of about 2 inches (cm 5) on each sku.

REV. 002 DEL 28/10/2020 | Pag. 2 of 2

Dante

Simplicity and a touch of classic style for this model. Voluptuous seats with just the right memory foam filling ensure ergonomic comfort.



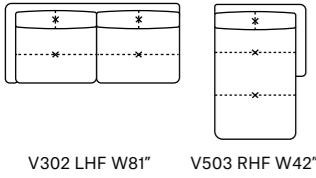
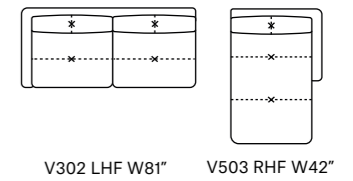

Dante

Dante is a style where simplicity takes form and design giving this model a minimalist-style look with a classic taste. In addition, the seat filled with the right combination of memory foam offers a great seating comfort that perfectly adapts to the body.

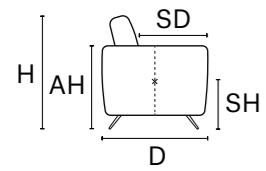

D 37" H 31" AH 25" SH 17" SD 23"

MAXI SEAT (version of the group have the same seat width)

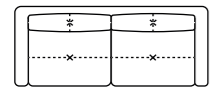

W 84"
V300 SOFA

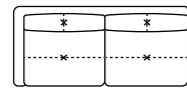

W 81"
V302 LHF SOFA

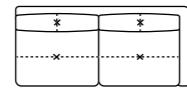

W 81"
V303 RHF SOFA

MEDIUM SEAT (version of the group have the same seat width)

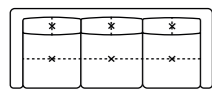

W 112"
V347 SOFA EXTRA
(3 CUSHIONS)

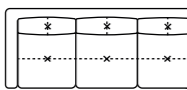

W 109"
V351 LHF SOFA EXTRA
(3 CUSHIONS)

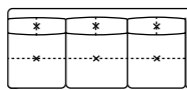

W 109"
V352 RHF SOFA EXTRA
(3 CUSHIONS)

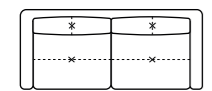

W 76"
V214 LOVESEAT MAXI

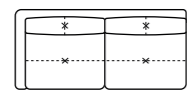

W 74"
V216 LHF LOVESEAT MAXI

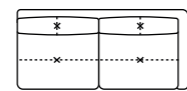

W 74"
V217 RHF LOVESEAT MAXI

SMALL SEAT (version of the group have the same seat width)

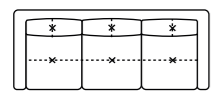

W 94"
V314 SOFA MAXI
(3 CUSHIONS)

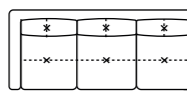

W 92"
V316 LHF SOFA MAXI
(3 CUSHIONS)

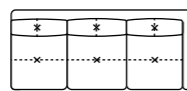

W 92"
V317 RHF SOFA MAXI
(3 CUSHIONS)

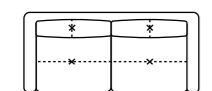

W 65"
V200 LOVESEAT

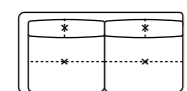

W 62"
V202 LHF LOVESEAT

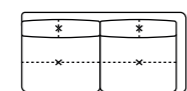

W 62"
V203 RHF LOVESEAT

JOLLY (can be combined with all the version group)

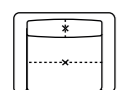

W 35"
V100 ARMCHAIR

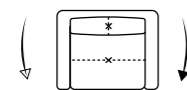

W 35"
V140 ARMCHAIR SWIVEL

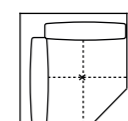

W 46"
D 46"
V400 CORNER

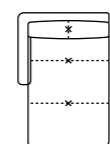

W 42"
D 63"
V502 LHF
CHAISE LONGUE MAXI

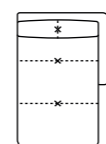

W 42"
D 63"
V503 RHF
CHAISE LONGUE MAXI



W 33"
D 24"
V600 OTTOMAN

Dante

Technical Description

decor stitch: "C" and "Z"

thick stitch: Available as option

structure: Hardwood frame for extra strength

seat/back suspension: Reinforced elastic webbing

seat cushion: High density ecologic open-cell polyurethane foam and memory foam covered with a layer of dacron wadding

back cushion: High density ecologic open-cell polyurethane foam covered with a layer of dacron wadding

removability: Seat and back cushions

foot option # 1: Stainless Steel Finish

foot option # 2: Stainless Steel Bronze Finish

Foot Finishing Option



Foot Option 1:
Stainless Steel Finish



Foot Option 2:
Stainless Steel Bronze Finish

Thin stitch standard



Thick stitch option



Decor Stich Option



Decor stitch:
Type C

Decor Stich Option

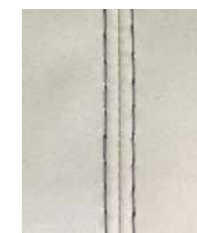

Decor stitch:
Type Z

LEATHER COLOR SHADE DIFFERENCES: The model upholstered with some Natural leather such as Maya, Moss, Carees and Sensation, could present in some area differences in color tones of about 5%. Such differences are not to be considered defect but an expression of the natural characteristic of the cowhide. The company reserves the right without prior notice to make technical sheets changes and/or materials for quality product improvement. Leather sofas are a handmade product and according to the leather covering selected there could be a measurement tolerance of about 2 inches (cm 5) on each sku.

REV. 002 DEL 28/10/2020 | Pag. 2 of 2

Discovery

A sofa that dialogs with every personal idea of comfort thanks to the movement of its backrests. Solutions to lay down, sit down, huddle up and finally let go.



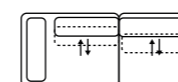

V316 LHF W81"

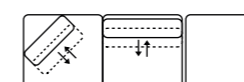

V428 RHF W102"

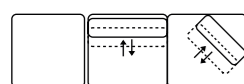

V427 LHF W102"

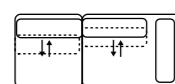

V317 RHF W81"

Discovery

Discovery has a very light and refined look. This stylish design has movable backrests transforming each seat in a comfortable chaise longue. Discovery is also characterised by special sartorial details which offer this model a true sense of charisma.

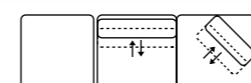

V427 LHF W102"

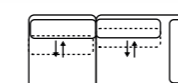

V317 RHF W81"

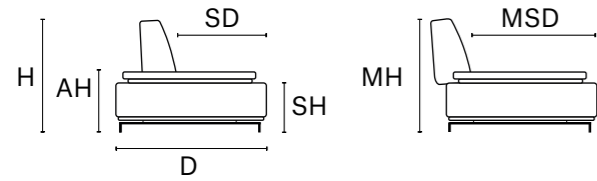

D 46" MD 56" H 34" AH 22" SH 17" SD 24" MSD 41" MH 35"

MAXI SEAT (version of the group have the same seat width)

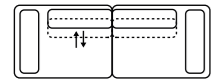

W 98"
V314 SOFA MAXI

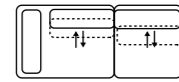

W 81"
V316 LHF SOFA MAXI

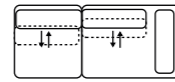

W 81"
V317 RHF SOFA MAXI



W 49"
V116 LHF ARMCHAIR MAXI



W 33"
V131 ARMLESS
CHAIR MAXI



W 49"
V117 RHF
ARMCHAIR MAXI

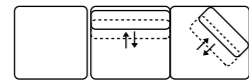

W 102"
V427 LHF CORNER CHAIR
MERIDIAN MAXI

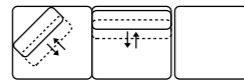

W 102"
V428 RHF CORNER CHAIR
MERIDIAN MAXI

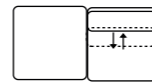

W 56"
V170 LHF CHAIR
MERIDIAN MAXI

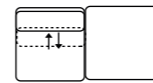

W 56"
V171 RHF CHAIR
MERIDIAN MAXI

MEDIUM SEAT (version of the group have the same seat width)

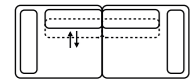

W 90"
V300 3 SOFA

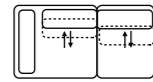

W 74"
V302 LHF SOFA

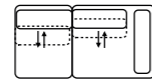

W 74"
V303 RHF 3 SOFA



W 45"
V101 LHF ARMCHAIR



W 29"
V103 ARMLESS CHAIR



W 45"
V102 RHF ARMCHAIR

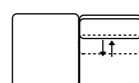

W 52"
V112 LHF CHAIR MERIDIAN

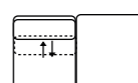

W 52"
V113 RHF CHAIR MERIDIAN

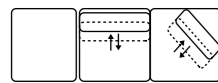

W 98"
V406 LHF CORNER CHAIR
MERIDIAN

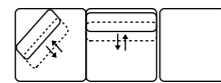

W 98"
V407 RHF CORNER CHAIR
MERIDIAN

JOLLY (can be combined with all the version group)

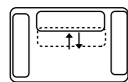

W 61"
V100 ARMCHAIR



W 46"
D 46"
V400 CORNER

Discovery

Technical Description

decor stitch available: Type "A" available as option

thick stitch: Available as option

structure: Hardwood frame fro extra strenght

seat/back suspension: Reinforced elastic webbing

seat/back cushions: High density ecologic open-cell polyurethane foam covered with a layer of dacron wadding

removability: Not available

mechanism: Backrest movable

foot option # 1: Stainless Steel Finish

foot option # 2: Stainless Steel Bronze Finish

foot option # 3: Stainless Steel Finish Sled

foot option # 4: Stainless Steel Bronze Finish Sled

covering: Full leather

Foot Finishing Option



Foot Option 1:
Stainless Steel Finish



Foot Option 2:
Stainless Steel Bronze Finish



Foot Option 3:
Stainless Steel Finish Sled



Foot Option 4:
Stainless Steel Bronze Finish Sled

Thin stitch standard



Thick stitch option



Decor Stich Option



Decor stitch:
Tipe A

LEATHER COLOR SHADE DIFFERENCES: The model upholstered with some Natural leather such as Maya, Moss, Carees and Sensation, could present in some area differences in color tones of about 5%. Such differences are not to be considered defect but an expression of the natural characteristic of the cowhide. The company reserves the right without prior notice to make technical sheets changes and/or materials for quality product improvement. Leather sofas are a handmade product and according to the leather covering selected there could be a measurement tolerance of about 2 inches (cm 5) on each sku.

REV. 002 DEL 28/10/2020 | Pag. 2 of 2

Fellini

Outlined by its visible stitching and characterized by its broad adjustable backrests, Fellini is an island of relaxation rested on a solid wood structure. Scenic.



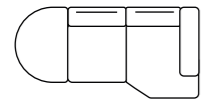

V406 LHF W103"

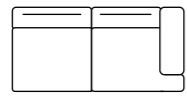

V317 RHF W80"



Fellini

Fellini is the result of a perfect balance between Design and extra soft seating Comfort with ratchet headrest adjustable in different positions. The upholstery is characterized by a sophisticated top-stitching that offers this model a surprising touch of elegance.

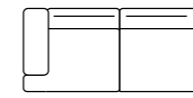

V316 LHF W80"

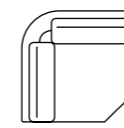

V400 LHF W49"

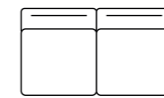

V315 W71"

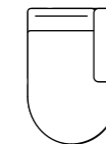

V503 RHF W45"



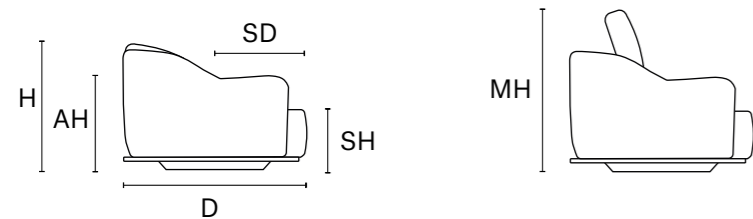

D 44" H 33" AH 26" SH 18" SD 24" MH 40"

MAXI SEAT (version of the group have the same seat width)

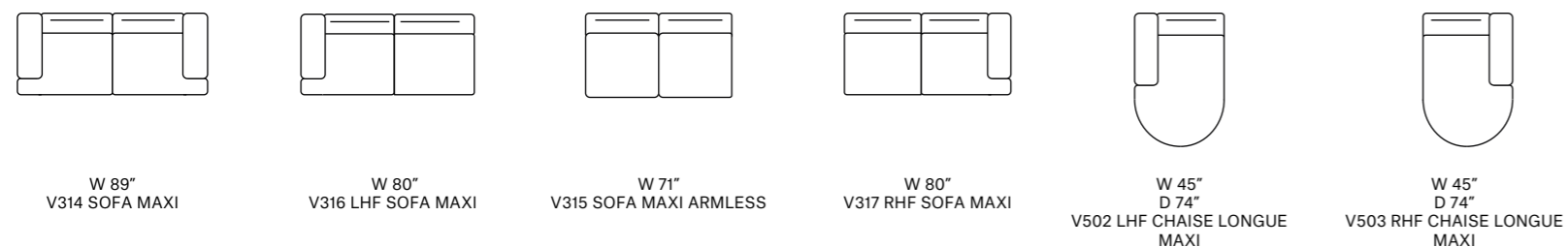

MEDIUM SEAT (version of the group have the same seat width)

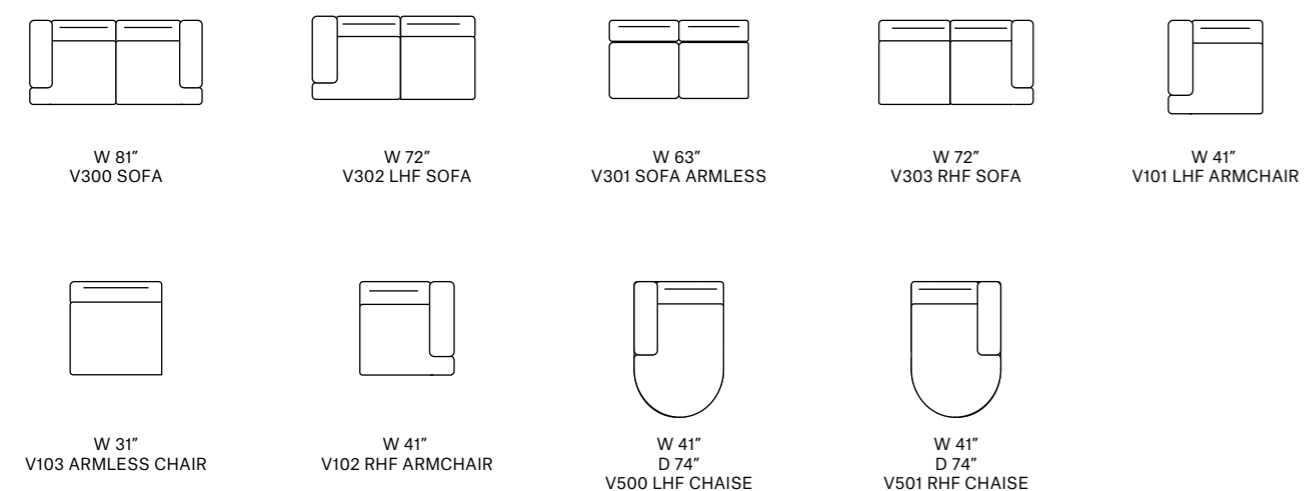

SMALL SEAT (version of the group have the same seat width)

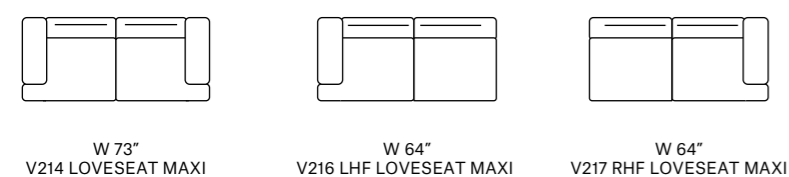

JOLLY (can be combined with all the version group)

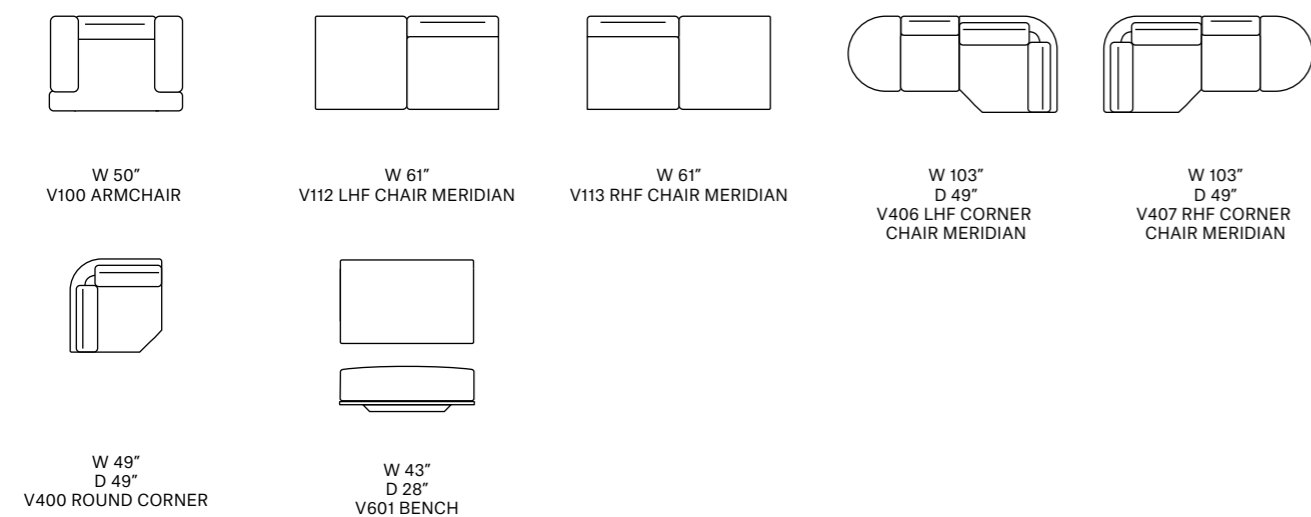

Fellini

Technical Description

decor stitch type: "I" Available as option
thick stitch: Available as option
structure: Hardwood frame for extra strength
seat/bach suspension: reinforced elastic webbing
seat cushion: High density ecologic open-cell polyurethane foam and memory foam covered with a layer of dacron wadding
back cushion: High density ecologic open-cell polyurethane foam covered with a layer of dacron wadding
mechanism: Manual ratchet headrest mechanism adjustable in different positions
removability: N.A.
sled option # 1: Stainless Steel Sled
sled option # 2: Stainless Sled Bronze Finish

Foot Finishing Option



Foot Option 1:
Stainless Steel Sled



Foot Option 2:
Stainless Sled Bronze Finish

Thin stitch standard



Thick stitch option



Decor Stich Option



Decor stitch:
Tipe I



LEATHER COLOR SHADE DIFFERENCES: The model upholstered with some Natural leather such as Maya, Moss, Carees and Sensation, could present in some area differences in color tones of about 5%. Such differences are not to be considered defect but an expression of the natural characteristic of the cowhide. The company reserves the right without prior notice to make technical sheets changes and/or materials for quality product improvement. Leather sofas are a handmade product and according to the leather covering selected there could be a measurement tolerance of about 2 inches (cm 5) on each sku.
 REV. 002 DEL 28/10/2020 | Pag. 2 of 2

Flow

The linear and sophisticated design makes Flow a furnishing element that speaks a timeless language. A sofa that perfectly adapts to every living room thanks to the modular seating and various strictly hand-crafted workmanship.



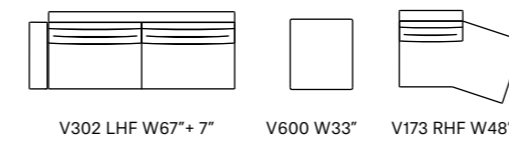
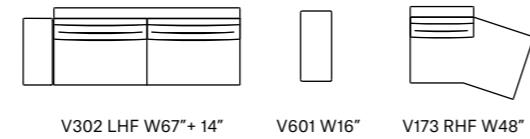

Flow

The large proportions and refined details underscore the high structural quality of this model. A base covered in leather runs along the entire length. The padding in certified polyurethane is a guarantee of comfort and respect for the environment. An alcove.

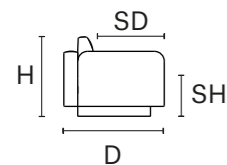

D 40" H 35" SH 18" SD 23"



MAXI SEAT (version of the group have the same seat width)

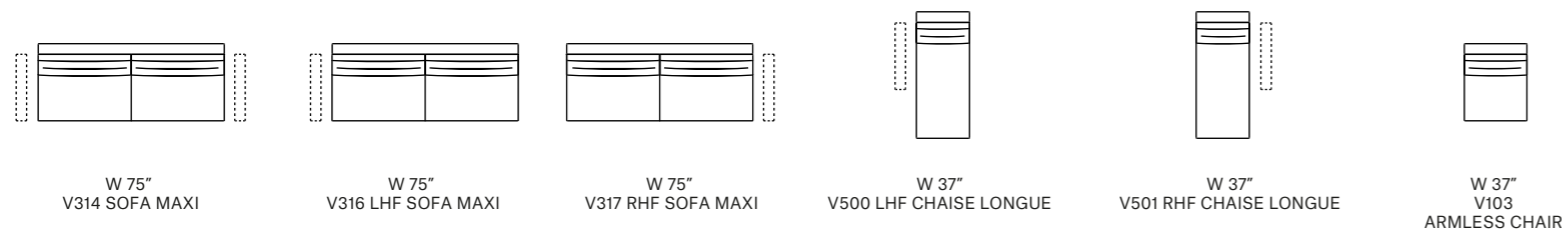

MEDIUM SEAT (version of the group have the same seat width)

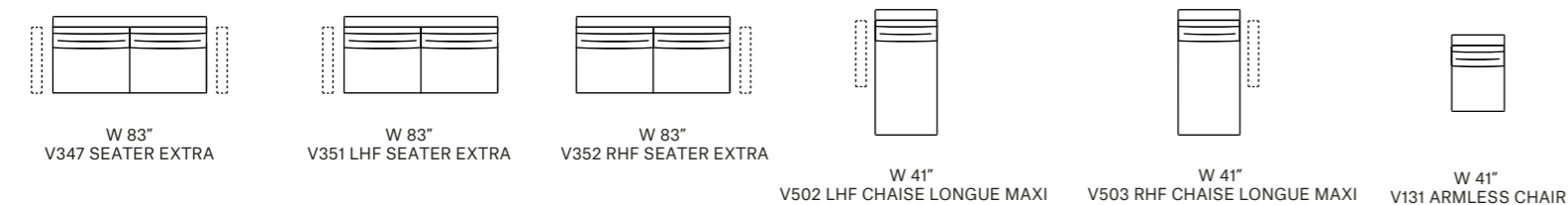

SMALL SEAT (version of the group have the same seat width)

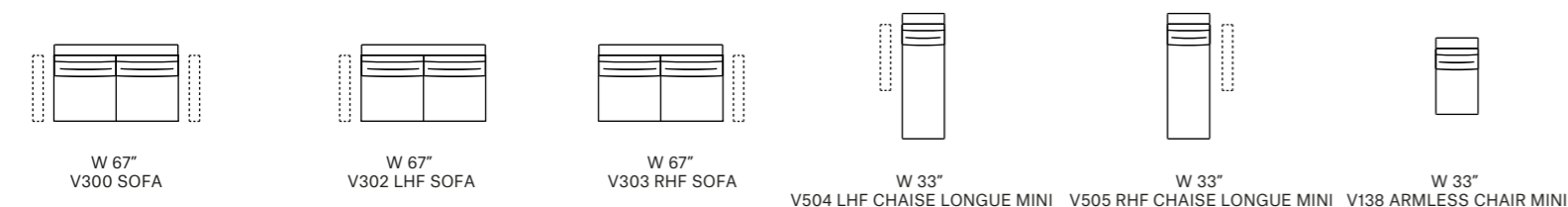

JOLLY (can be combined with all the version group)

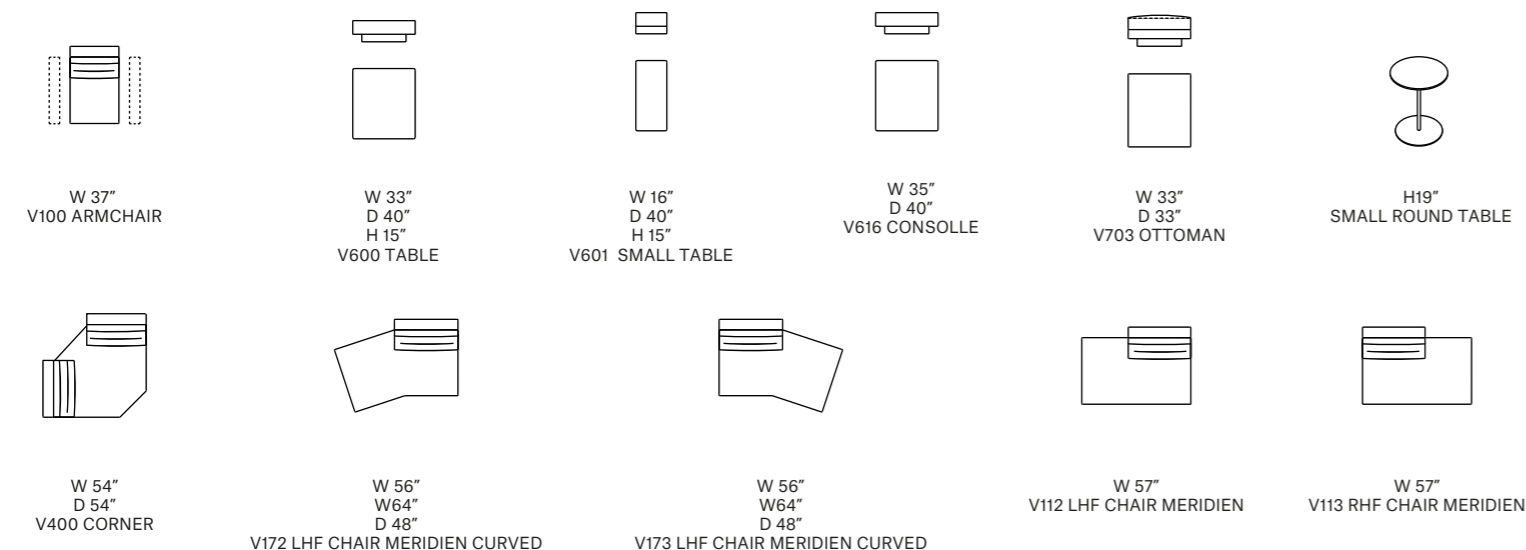

Flow

Technical Description

- thick stitch:** Available as option
- structure:** Hardwood frame for extra strenght
- seat/back suspension:** Reinforced elastic webbing
- seat cushion:** High density ecologic open cell polyurethane foam, pocket spring, and memory foam covered with a layer of dacron wadding
- back cushions:** High density ecologic open cell polyurethane foam, covered with a layer of dacron wadding
- removability:** Back and Seat cushions
- base:** Covered with leather, possibility to choose the color, same of the sofa or different

Important notice for the sofa dimension

Each SKU indicates only the width of the inside seats/backs without the arm. For the total width of the SKU, pls kindly choose your favorite arm (Wide or Thin) and add the width of the selected one.



Wide arm:
Add 14" for each arm
Arm height 23"



Thin arm:
Add 7" for each arm
Arm height 26"

Thin stitch standard



Thick stitch option



LEATHER COLOR SHADE DIFFERENCES: The model upholstered with some Natural leather such as Maya, Moss, Carees and Sensation, could present in some area differences in color tones of about 5%. Such differences are not to be considered defect but an expression of the natural characteristic of the cowhide. The company reserves the right without prior notice to make technical sheets changes and/or materials for quality product improvement. Leather sofas are a handmade product and according to the leather covering selected there could be a measurement tolerance of about 2 inches (cm 5) on each sku.
REV. 002 DEL 28/10/2020 | Pag. 2 of 2

Glamour

Exclusive design, embellished by the quilted seats testifying to its craftsmanship. A stylish detail in the metal feet with original features.

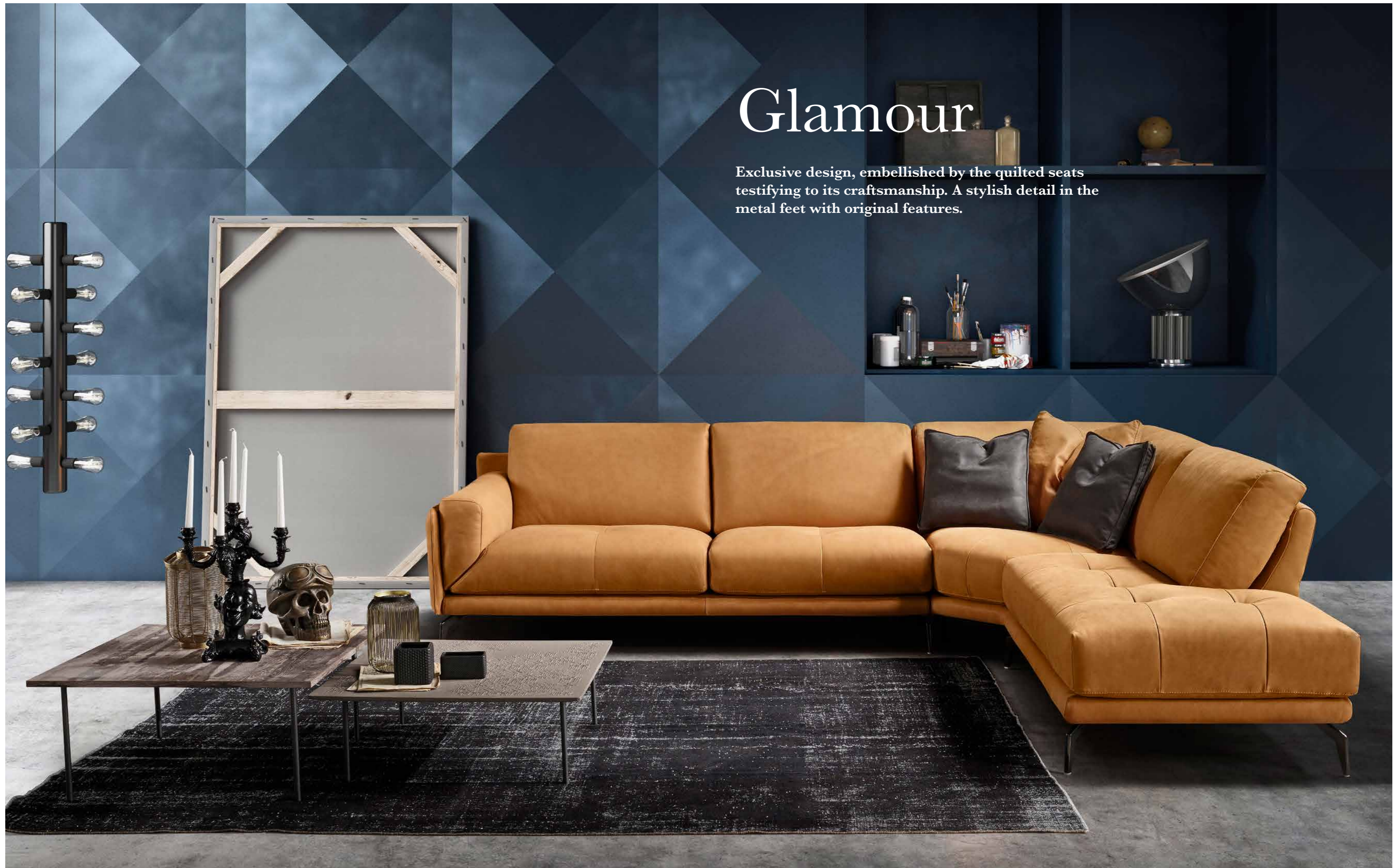

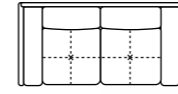

V314 W91"

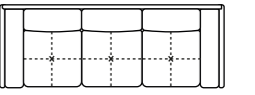

V242 W103"

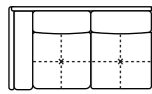

V316 LHF W81"

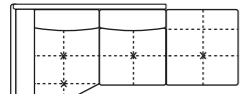

V407 RHF W105"

Glamour

Glamour is characterized by a special design where the seat and backrest cushions are rested on a linear frame offering a sartorial arm detail. A single central topstitch on the seat offers this model a true sense of charisma.

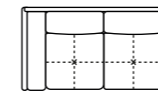

V316 LHF W81"

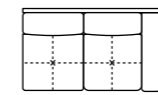

V317 RHF W81"

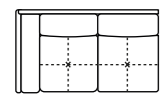

V316 LHF W81"

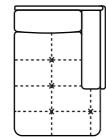

V503 LHF W45"

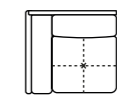

V116 LHF W45"

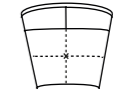

V165 W56"

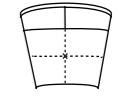

V165 W56"

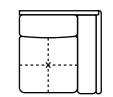

V117 RHF W45"



Glamour

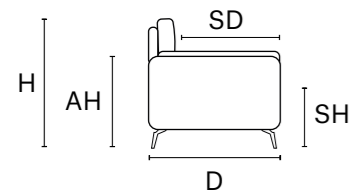



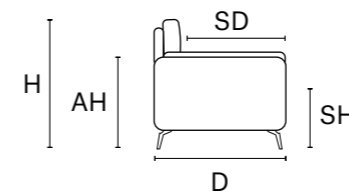

D 38" H 35" AH 26" SH 19" SD 23"



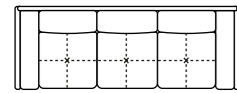
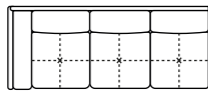
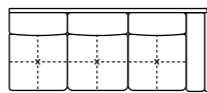
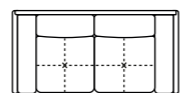
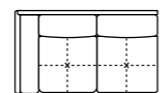
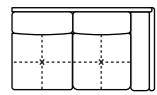
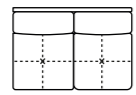
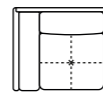

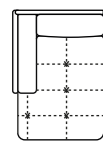
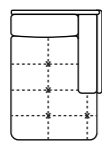

D 38" H 35" AH 26" SH 19" SD 23"

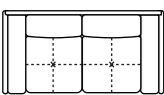
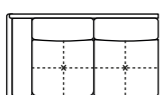
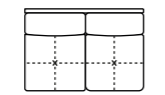
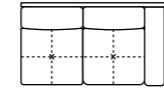

MAXI SEAT (version of the group have the same seat width)

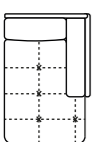
| | | | | |
|--|--|---|---|--|
|  W 128" V342 SOFA MAXI EXTRA |  W 118" V349 LHF SOFA MAXI EXTRA |  W 118" V350 RHF SOFA MAXI EXTRA |  W 91" V314 SOFA MAXI |  W 81" V316 LHF SOFA MAXI |
|  W 81" V317 RHF SOFA MAXI |  W 72" V315 SOFA MAXI ARMLESS |  W 45" V116 LHF ARMCHAIR MAXI |  W 36" V131 ARMLESS CHAIR MAXI |  W 45" V117 RHF ARMCHAIR MAXI |
|  W 45" D 69" SD 51" V502 LHF CHAISE LONGUE MAXI |  W 45" D 69" SD 51" V503 RHF CHAISE LONGUE MAXI |  W 56" D 46" V165 ARMLESS CHAIR MAXI CURVED | | |



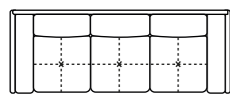
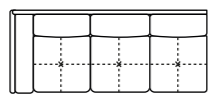
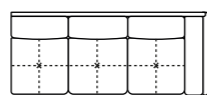
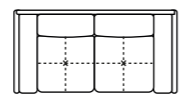
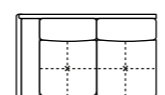
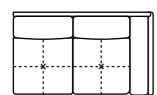

MEDIUM SEAT (version of the group have the same seat width)

| | | | | |
|---|--|--|--|--|
|  W 83" V300 SOFA |  W 73" V302 LHF SOFA |  W 64" V301 SOFA ARMLESS |  W 73" V303 RHF SOFA |  W 41" D 69" V500 LHF CHAISE LONGUE |
|  W 41" D 69" V501 RHF CHAISE LONGUE |  W 32" V103 ARMLESS CHAIR | | | |

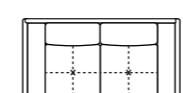

SMALL SEAT (version of the group have the same seat width)

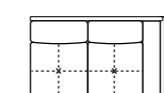
| | | | | |
|--|--|--|--|---|
|  W 103" V242 LOVESEAT MAXI EXTRA |  W 93" V243 LHF LOVESEAT MAXI EXTRA |  W 93" V244 RHF LOVESEAT MAXI EXTRA |  W 75" V214 LOVESEAT MAXI |  W 65 V216 LHF LOVESEAT MAXI |
|  W 65 V217 RHF LOVESEAT MAXI |  W 37" V136 LHF ARMCHAIR MINI |  W 37" V137 RHF ARMCHAIR MINI | | |

X SMALL (can be combined with all the version group)

| | | | | |
|---|---|---|---|---|
|  W 67" V200 LOVESEAT D |  W 57" V202 LHF LOVESEAT |  W 57" V203 RHF LOVESEAT |  W 35" V101 LHF ARMCHAIR |  W 35" V102 RHF ARMCHAIR |
|---|---|---|---|---|

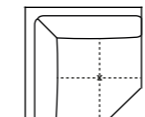
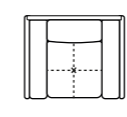
JOLLY (can be combined with all the version group)

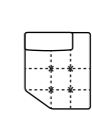
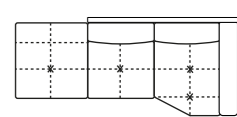
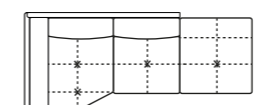
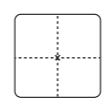
| | | | | |
|--|---|---|---|--|
|  W 48" D 48" V400 CORNER |  W 44" V100 ARMCHAIR |  W 54" D 48" V112 LHF ARMCHAIR MERIDIAN |  W 54" D 48" V113 RHF ARMCHAIR MERIDIAN |  W 105" D 48" V406 LHF CORNER CHAIR MERIDIAN |
|  W 105" D 48" V407 RHF CORNER CHAIR MERIDIAN |  W 35" D 35" V611 OTTOMAN | | | |

Technical Description

- special stitch "D"**: Available as option
- thick stitch**: Not available
- structure**: Hardwood frame with metal insert for extra strenght
- seat/back suspension**: Reinforced elastic webbing
- seat/back cushions**: High density ecologic open-cell polyurethane foam covered with a layer of dacron wadding
- removability**: Arm, back and seat cushions
- mechanism**: N.A.
- foot option # 1**: Stainless Steel Finish
- foot option # 2**: Stainless Steel Bronze Finish

Foot Finishing Option



Foot Option 1:
Stainless Steel Finish



Foot Option 2:
Stainless Steel Bronze Finish

Thin stitch standard



Decor Stitch



Decor Stitch :
Tipe "D"

LEATHER COLOR SHADE DIFFERENCES: The model upholstered with some Natural leather such as Maya, Moss, Carees and Sensation, could present in some area differences in color tones of about 5%. Such differences are not to be considered defect but an expression of the natural characteristic of the cowhide. The company reserves the right without prior notice to make technical sheets changes and/or materials for quality product improvement. Leather sofas are a handmade product and according to the leather covering selected there could be a measurement tolerance of about 2 inches (cm 5) on each sku.

Gosh

Cozy dimensions and a linear design. The enveloping look of Gosh is in fact harmoniously contrasted by the meticulous lines of the backrests and armrests, giving the sofa a light and balanced feel.



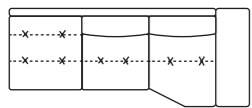

V406 LHF W104"

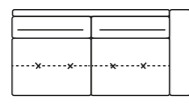

V317 RHF W79"



V314 W86"

Gosh

Gosh is a style where simplicity takes form and design, giving this model a minimalist-style look with a classic taste. In addition, the seat filled with the right combination of memory foam offers a great seating comfort which perfectly adapts to the body



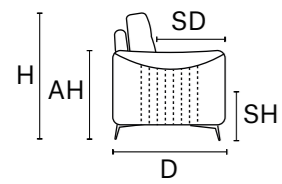

D 39" H 34" AH 24" SH 19" SD 22"

MAXI SEAT (version of the group have the same seat width)

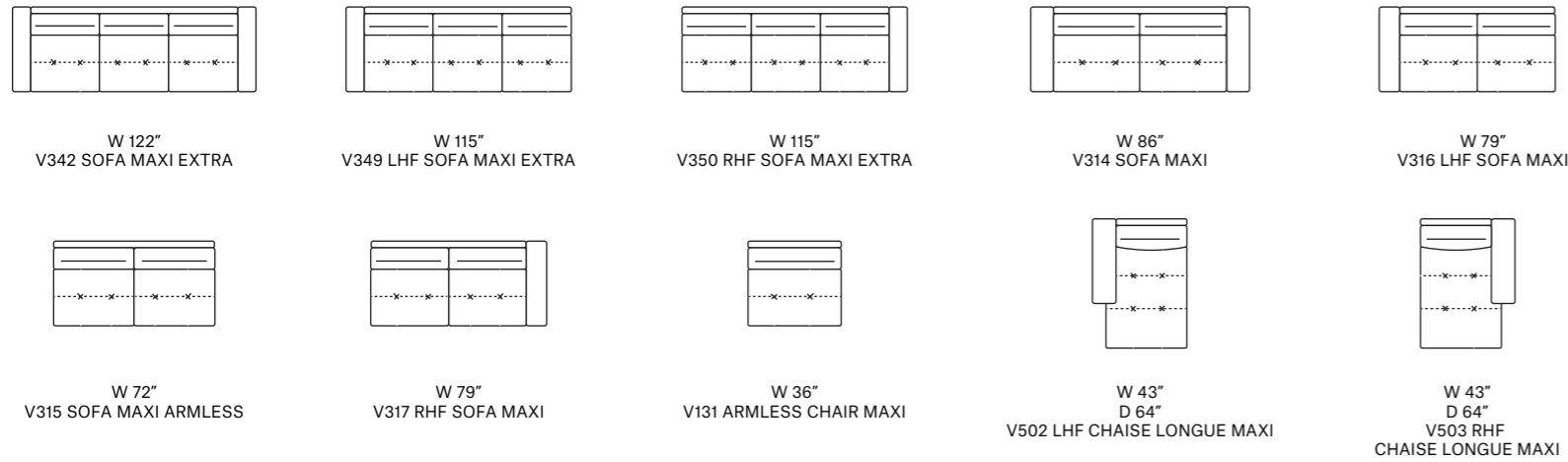

MEDIUM SEAT (version of the group have the same seat width)

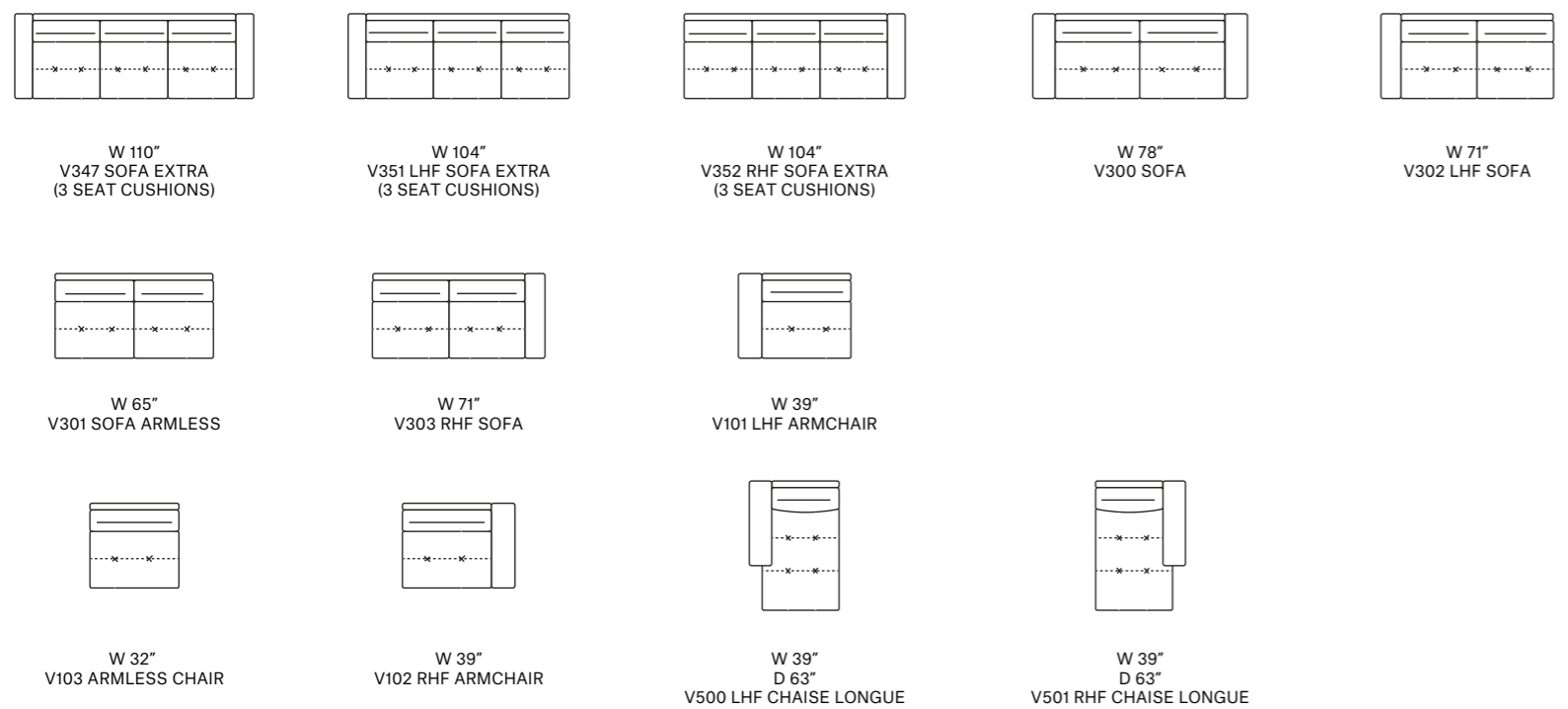

SMALL SEAT (version of the group have the same seat width)

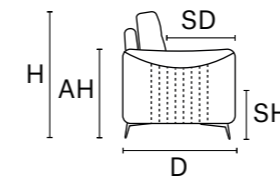
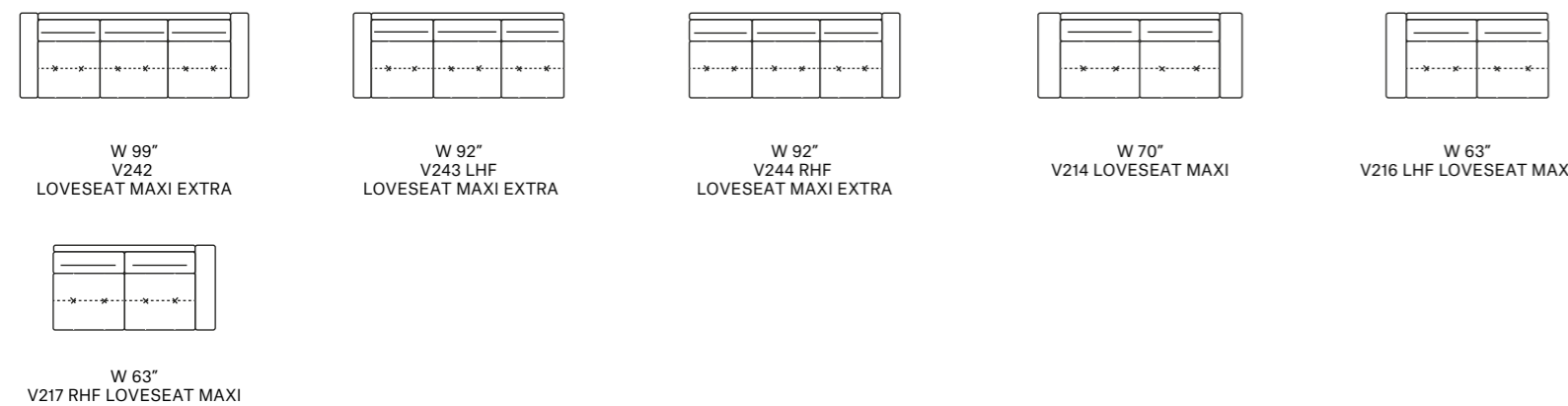

D 39" H 34" AH 24" SH 19" SD 22"

X SMALL SEAT (version of the group have the same seat width)

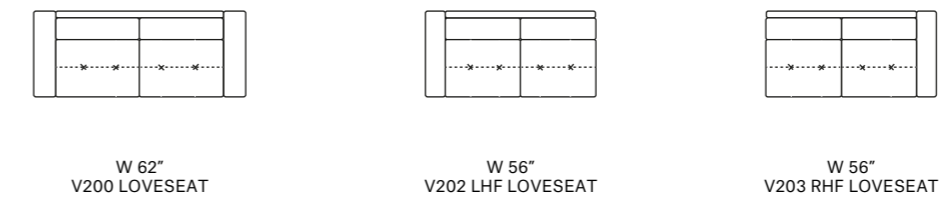

JOLLY (can be combined with all the version group)

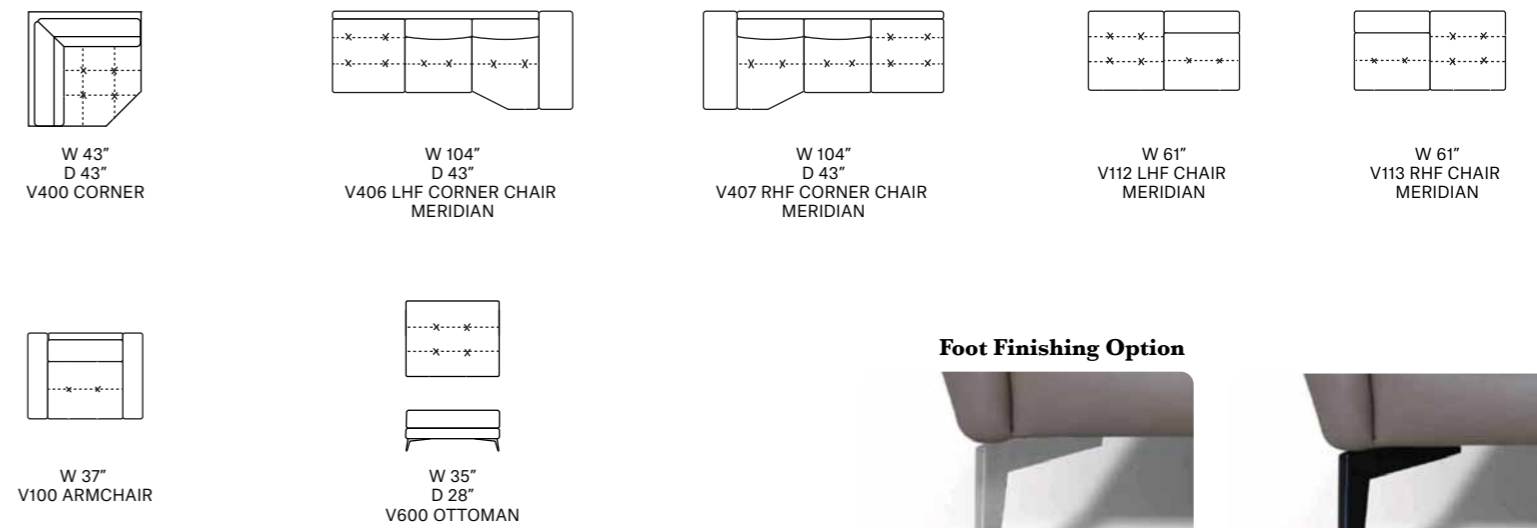

Foot Finishing Option



Foot Option 1:
Stainless Steel Finish

Foot Option 2:
Stainless Steel Bronze Finish

Thin stitch standard



Thick stitch option



Gosh

Technical Description

- thick stitch:** Available as option
- structure:** Hardwood frame for extra strength
- seat/back suspension:** Reinforced elastic webbing
- removability:** Seat and back cushions
- seat cushion:** High density ecologic polyurethane foam and memory foam covered with a layer of dacron wadding
- back cushion:** High density ecologic open-cell polyurethane foam covered with a layer of dacron wadding
- foot option # 1:** Stainless Steel Finish
- foot option # 2:** Stainless Steel Bronze Finish

LEATHER COLOR SHADE DIFFERENCES: The model upholstered with some Natural leather such as Maya, Moss, Carees and Sensation, could present in some area differences in color tones of about 5%. Such differences are not to be considered defect but an expression of the natural characteristic of the cowhide. The company reserves the right without prior notice to make technical sheets changes and/or materials for quality product improvement. Leather sofas are a handmade product and according to the leather covering selected there could be a measurement tolerance of about 2 inches (cm 5) on each sku.

Grow

The linear and sophisticated design makes Grow a furnishing element that speaks a timeless language. A sofa that perfectly adapts to every living room thanks to the modular seating and various strictly hand-crafted workmanship.



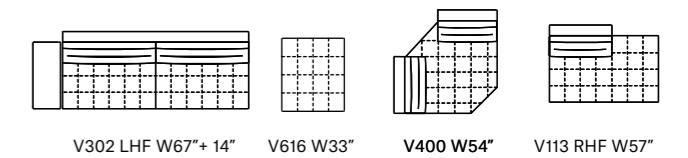
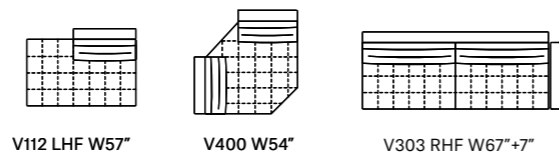

Grow

The large proportions and refined details underscore the high structural quality of this model. A base covered in leather runs along the entire length. The padding in certified polyurethane is a guarantee of comfort and respect for the environment. An alcove.

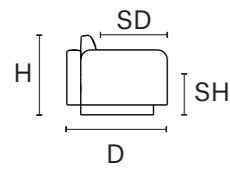

D 40" H 35" SH 18" SD 23"

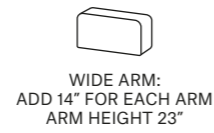

MAXI SEAT (version of the group have the same seat width)

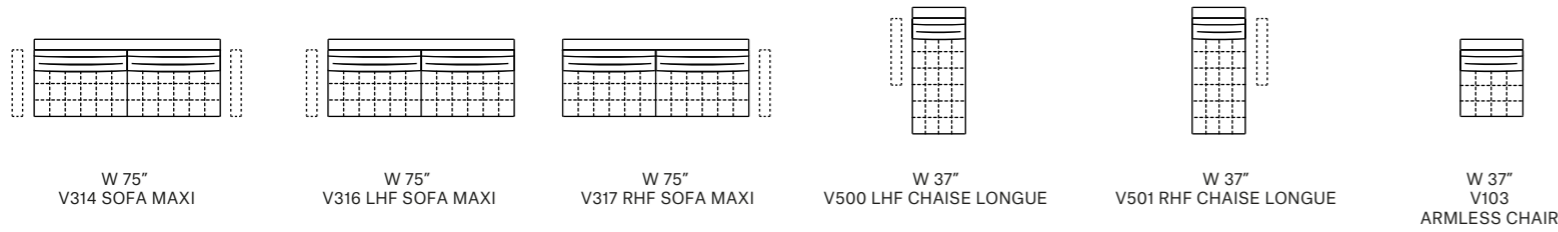

MEDIUM SEAT (version of the group have the same seat width)

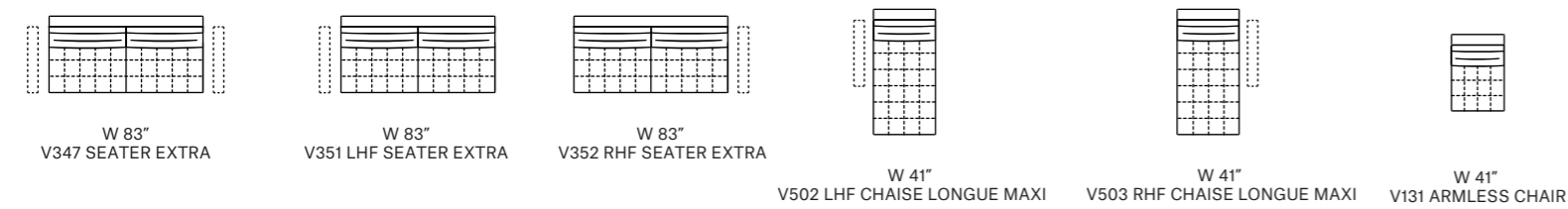

SMALL SEAT (version of the group have the same seat width)

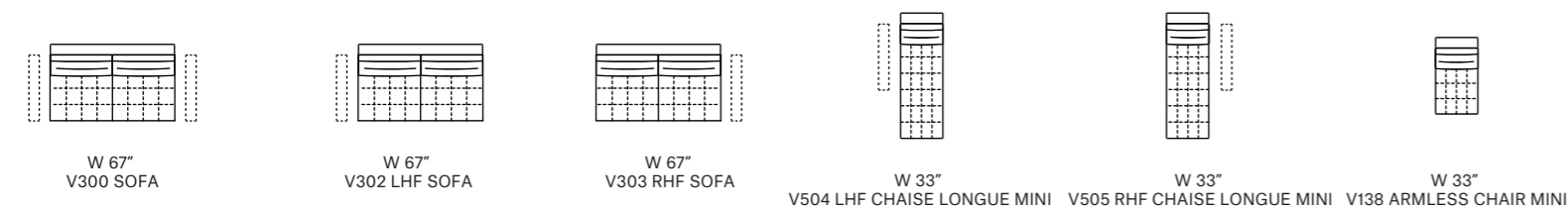

JOLLY (can be combined with all the version group)

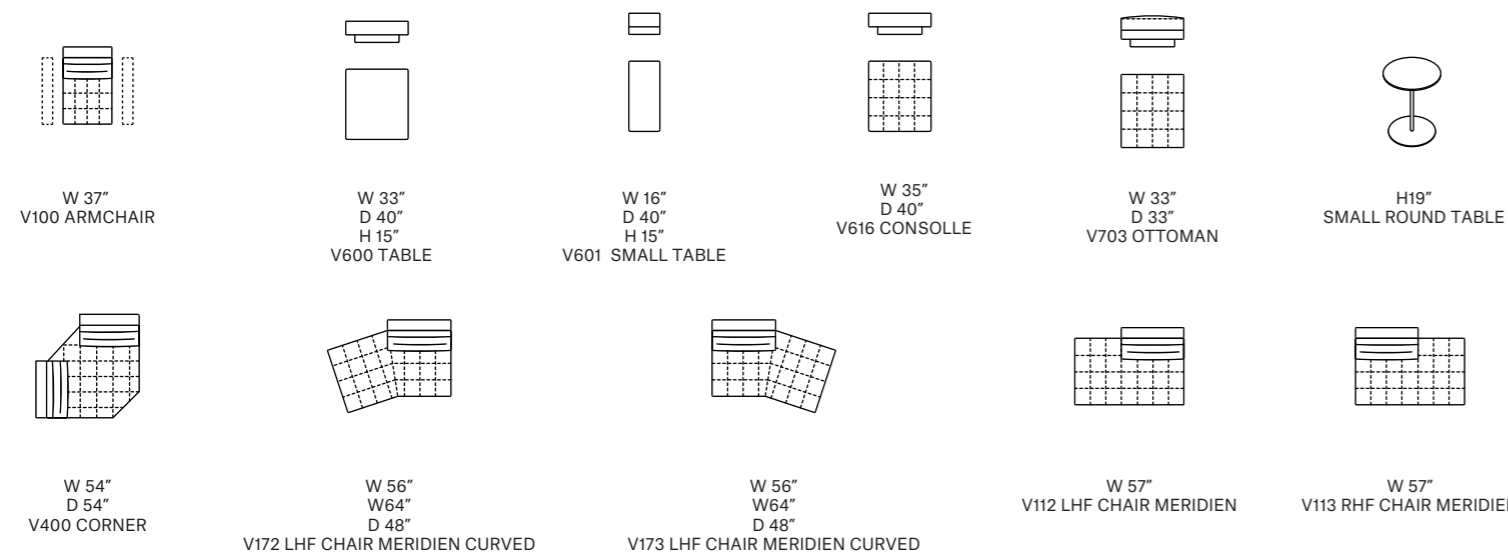

Grow

Technical Description

- thick stitch:** Available as option
- structure:** Hardwood frame for extra strenght
- seat/back suspension:** Reinforced elastic webbing
- seat cushion:** High density ecologic open cell polyurethane foam, pocket spring, and memory foam covered with a layer of dacron wadding
- back cushions:** High density ecologic open cell polyurethane foam, covered with a layer of dacron wadding
- removability:** Back and Seat cushions
- base:** Covered with leather, possibility to choose the color, same of the sofa or different

Important notice for the sofa dimension

Each SKU indicates only the width of the inside seats/backs without the arm. For the total width of the SKU, pls kindly choose your favorite arm (Wide or Thin) and add the width of the selected one.



Wide arm:
Add 14" for each arm
Arm height 23"



Thin arm:
Add 7" for each arm
Arm height 26"

Thin stitch standard



Thick stitch option



LEATHER COLOR SHADE DIFFERENCES: The model upholstered with some Natural leather such as Maya, Moss, Carees and Sensation, could present in some area differences in color tones of about 5%. Such differences are not to be considered defect but an expression of the natural characteristic of the cowhide. The company reserves the right without prior notice to make technical sheets changes and/or materials for quality product improvement. Leather sofas are a handmade product and according to the leather covering selected there could be a measurement tolerance of about 2 inches (cm 5) on each sku.
REV. 002 DEL 28/10/2020 | Pag. 2 of 2

Icaro

The spacious seats offer ideal relaxation. The design is minimalist and creates a lighthearted and harmonious atmosphere that speaks of a modern style.



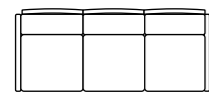

V342 W132"

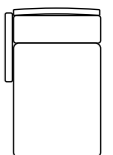

V502 LHF W48"



V317 RHF W87"

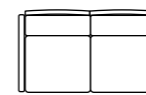

V316 LHF W87"

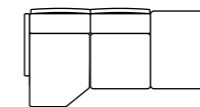

V407 RHF W105"



Icaro

Icaro is an impressive crafted sofa with a sophisticated thin arm and wide seat patterns. In addition, the seat and back is composed of memory foam and the extreme soft seating comfort perfectly adapts to the body.

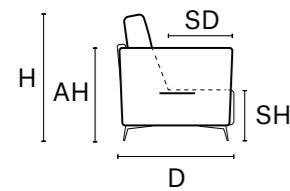

D 37" H 35" AH 28" SH 18" SD 23"

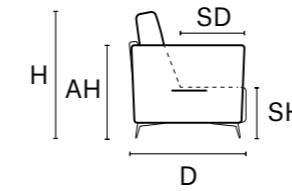

D 37" H 35" AH 28" SH 18" SD 23"

MAXI SEAT (version of the group have the same seat width)

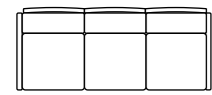

W 132"
V342 SOFA MAXI EXTRA

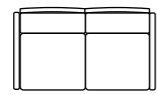

W 92"
V314 SOFA MAXI

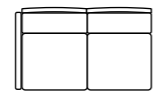

W 87"
V316 LHF SOFA MAXI

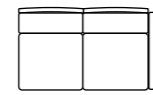

W 87"
V317 RHF SOFA MAXI

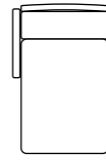

W 48"
D 61"
SD 47"
V502 LHF CHAISE LONGUE MAXI

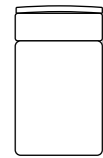

W 48"
D 61"
SD 47"
V503 RHF CHAISE LONGUE MAXI

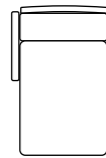

W 53"
D 61"
SD 47"
V531 CHAISE LONGUE MAXI
FREE STANDING

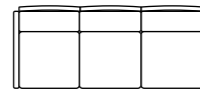

W 127"
V349 LHF SOFA MAXI EXTRA

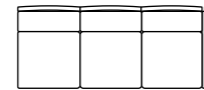

W 127"
V350 RHF SOFA MAXI EXTRA

MEDIUM SEAT (version of the group have the same seat width)

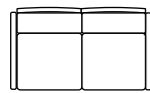

W 82"
V300 SOFA

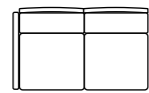

W 77"
V302 LHF SOFA

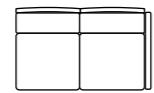

W 77"
V303 RHF SOFA

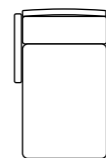

W 43"
D 61"
SD 47"
V500 LHF CHAISE LONGUE

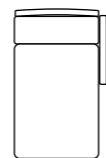

W 43"
D 61"
SD 47"
V501 RHF CHAISE LONGUE

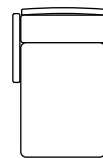

W 48"
D 61"
SD 47"
V530 CHAISE LONGUE
FREE STANDING



W 43"
V114 LHF ARMCHAIR MEDIUM



W 43"
V115 RHF ARMCHAIR MEDIUM

SMALL SEAT (version of the group have the same seat width)



W 72"
V214 LOVESEAT MAXI



W 67"
V216 LHF LOVESEAT MAXI

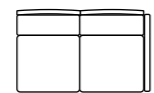

W 67"
V217 RHF LOVESEAT MAXI

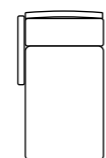

W 36"
D 61"
SD 47"
V504 LHF CHAISE LONGUE MINI

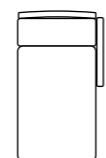

W 36"
D 61"
SD 47"
V505 RHF CHAISE LONGUE MINI

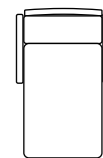

W 43"
D 61"
SD 47"
V532 CHAISE LONGUE MINI
FREE STANDING

JOLLY (can be combined with all the version group)



W 38"
D 28"
V600 OTTOMAN

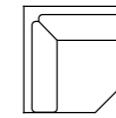

W 45"
D 45"
V400 CORNER

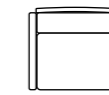

W 41"
V100 ARMCHAIR

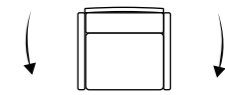

W 41"
V140 ARMCHAIR SWIVEL

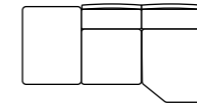

W 105"
D 45"
V406 LHF CORNER
CHAIR MERIDIAN

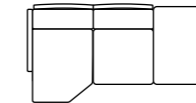

W 105"
D 45"
V407 RHF CORNER
CHAIR MERIDIAN

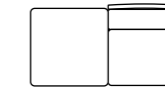

W 60"
V112 LHF CHAIR MERIDIAN

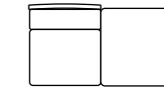

W 60"
V113 RHF CHAIR MERIDIAN



W 28"
D 35"
V601 BENCH



W 20"
D 20"
H 4"
V629 MEDIUM CUSHION

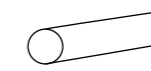

W 20"
D 6"
V602 ROLL



W 20"
D 6"
V603 CUSHION

Thin stitch standard



Thick stitch option



Decor Stich Option



Decor stitch:
Tipe E

Foot Finishing Option



Foot Option 1:
Stainless Steel Finish



Foot Option 2:
Stainless Steel Bronze Finish

Technical Description

decor stitch: type " E " available as option

thick stitch: available as option

structure: hardwood frame and metal for extra strength

spring system: Reinforced elastic webbing

seat cushion: High density ecologic open-cell polyurethane foam and memory foam covered with a layer of dacron wadding

back cushion: High density ecologic open-cell polyurethane foam covered with a layer of dacron wadding

removability: Back cushions

mechanisms: Not available

foot option 1: Stainless Steel Finish

foot option 2: Stainless Steel Bronze Finish

LEATHER COLOR SHADE DIFFERENCES: The model upholstered with some Natural leather such as Maya, Moss, Carees and Sensation, could present in some area differences in color tones of about 5%. Such differences are not to be considered defect but an expression of the natural characteristic of the cowhide. The company reserves the right without prior notice to make technical sheets changes and/or materials for quality product improvement. Leather sofas are a handmade product and according to the leather covering selected there could be a measurement tolerance of about 2 inches (cm 5) on each sku.

Karma

Karma is an elegant model with sophisticated sartorial details and manual ratchet backs. In addition, the seat filled with the right combination of memory foam offers a great supporting seating comfort.



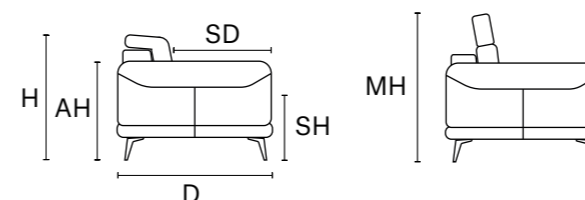

D 43" H 33" AH 25" SH 19" SD 23" MH 43"

MAXI SEAT (version of the group have the same seat width)

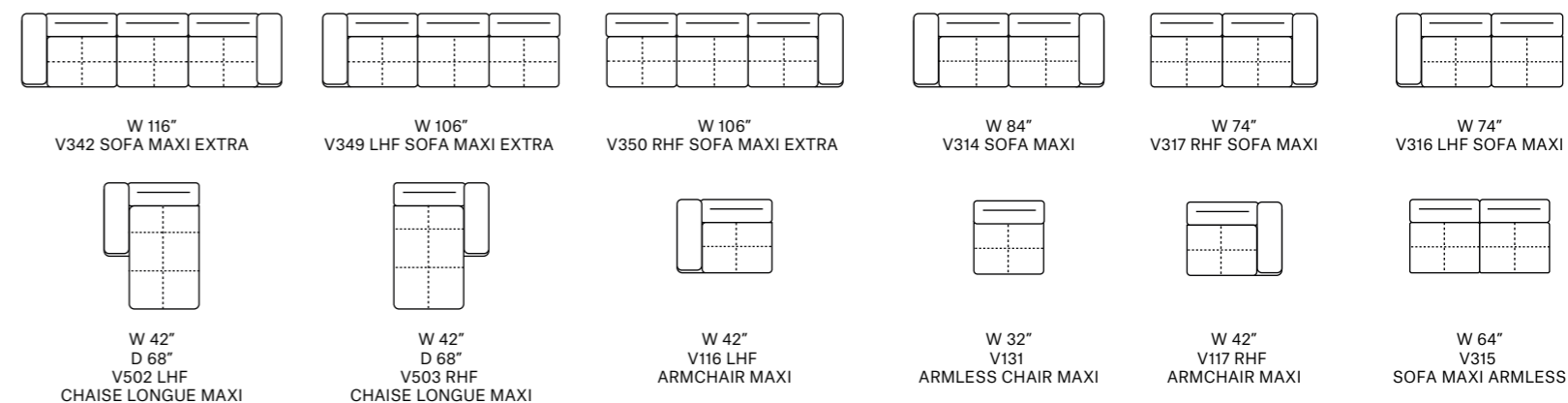

MEDIUM SEAT (version of the group have the same seat width)

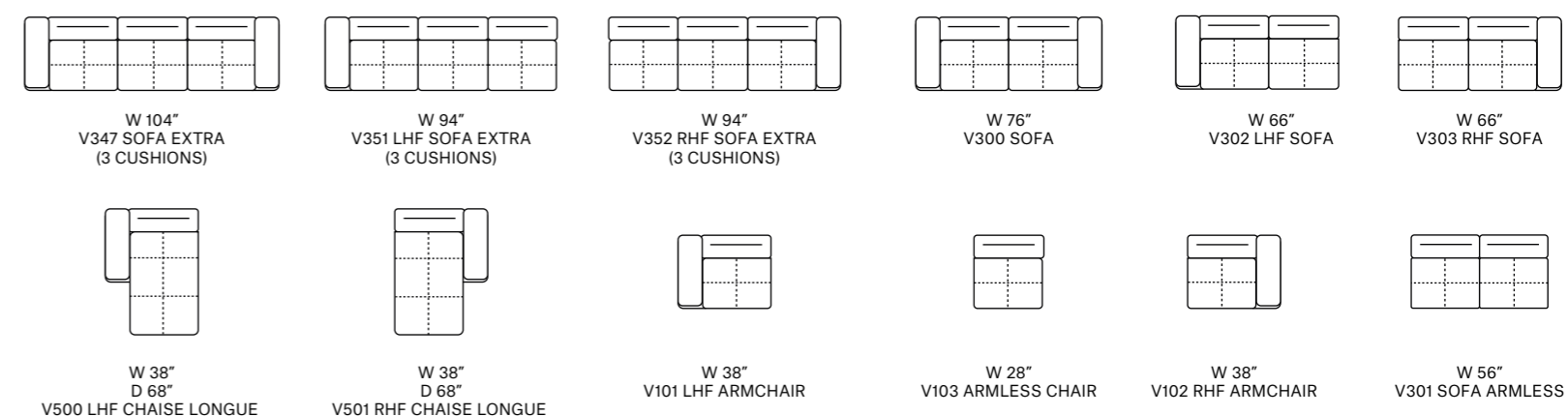

SMALL SEAT (version of the group have the same seat width)

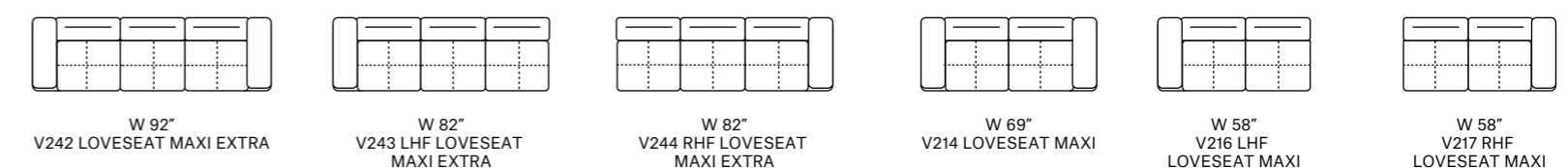

JOLLY (can be combined with all the version group)

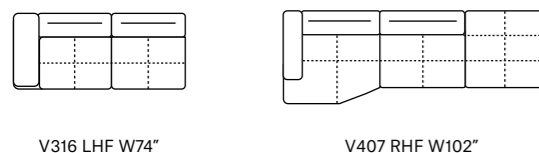
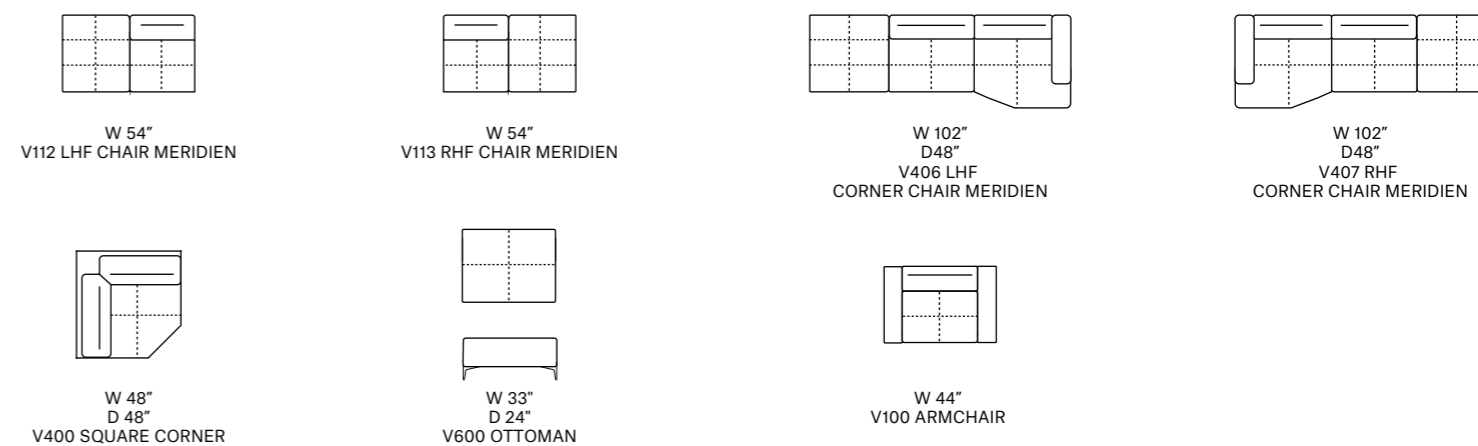

Foot Finishing Option



Foot Option 1:
Stainless Steel Finish

Foot Option 2:
Stainless Steel Bronze Finish

Thin stitch standard



Thick stitch option



Decor Stich Option



Decor stitch:
Tipe "B"

Karma

Technical Description

decor stitch: "B" Available as option

thick stitch: Available as option

structure: Hardwood frame for extra strength

seat/back suspension: Reinforced elastic webbing

seat cushion: High density ecologic open-cell polyurethane foam and memory foam covered with a layer of dacron wadding

back cushion: High density ecologic open-cell polyurethane foam covered with a layer of dacron wadding

removability: Not available

mechanism: Manual headrest

foot option # 1: Stainless Steel Finish

foot option # 2: Stainless Steel Bronze Finish

LEATHER COLOR SHADE DIFFERENCES: The model upholstered with some Natural leather such as Maya, Moss, Carees and Sensation, could present in some area differences in color tones of about 5%. Such differences are not to be considered defect but an expression of the natural characteristic of the cowhide. The company reserves the right without prior notice to make technical sheets changes and/or materials for quality product improvement. Leather sofas are a handmade product and according to the leather covering selected there could be a measurement tolerance of about 2 inches (cm 5) on each sku.

Living

The line of comfort is never interrupted in this sofa, designed and built to welcome. This is where we find the extraordinary simplicity of truly living the home.



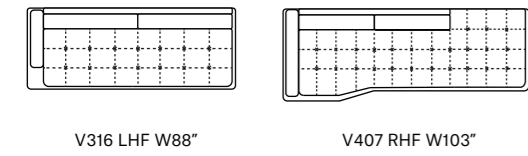

Living

Living is a style where simplicity takes form and design giving this model a minimalist-style look with a classic taste. In addition, the seat and back filled with the right combination of memory foam offers a great seat comfort which perfectly adapts to the body. This model is also characterized by an elegant tufting which gives a unique craft look.

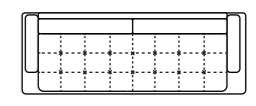

V314 W94"

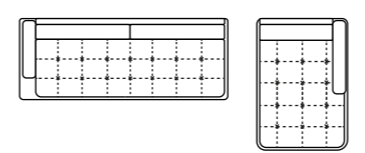

V316 LHF W88" V503 RHF W43"



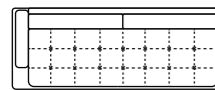

V316 LHF W88"

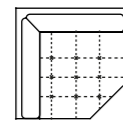

V400 W44"

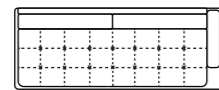

V317 RHF W88"



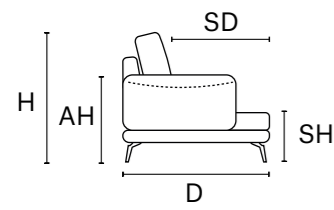

D 39" H 33" AH 23" SH 18" SD 22"

MAXI SEAT (version of the group have the same seat width)

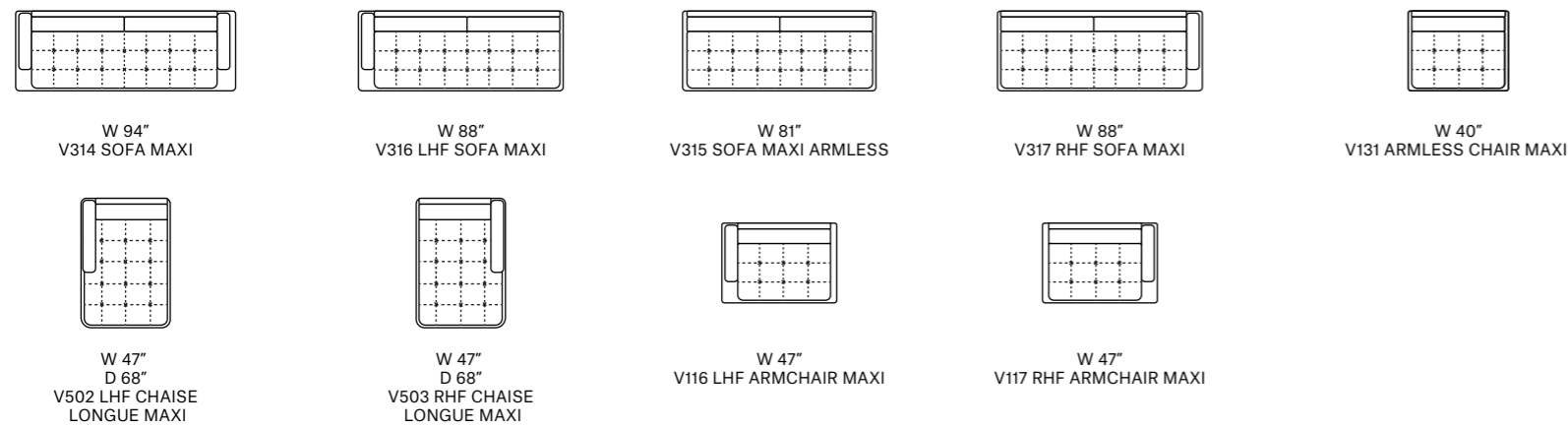

MEDIUM SEAT (version of the group have the same seat width)

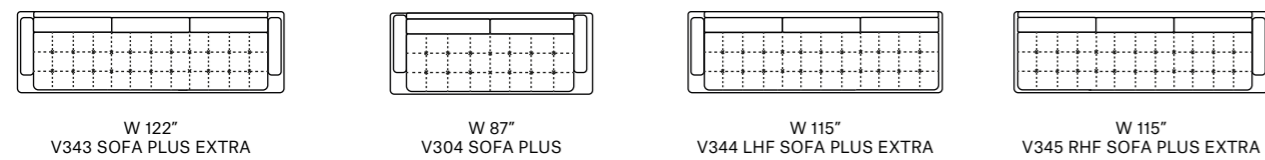

SMALL SEAT (version of the group have the same seat width)

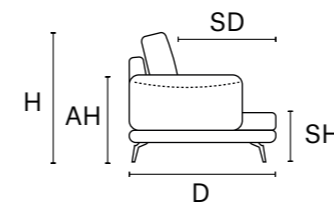
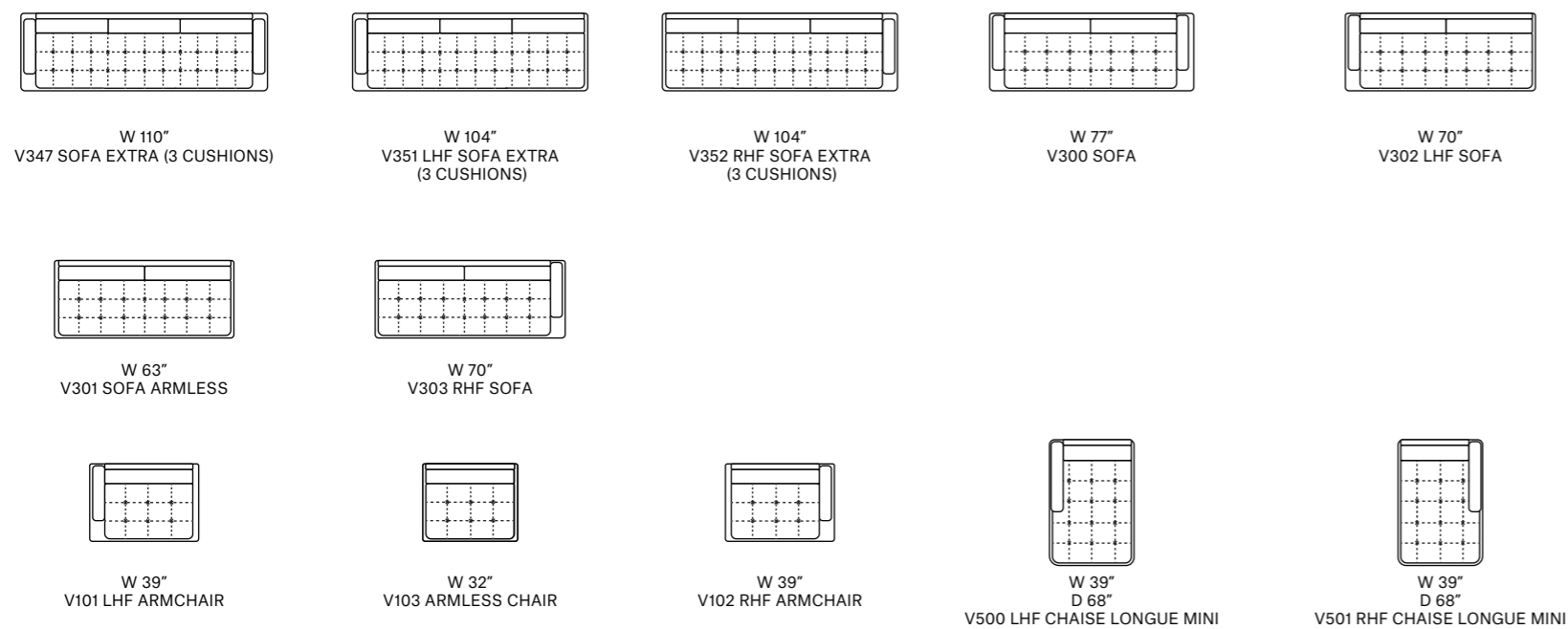

D 39" H 33" AH 23" SH 18" SD 22"

XSMALLSEAT (version of the group have the same seat width)

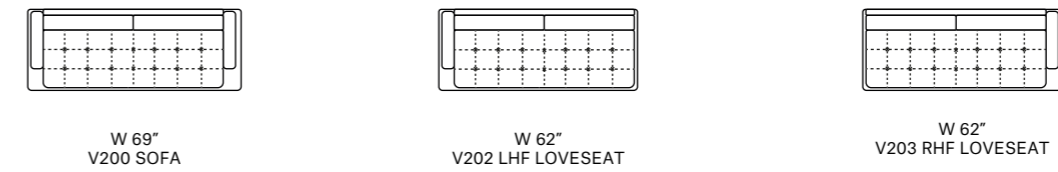

JOLLY (can be combined with all the version group)

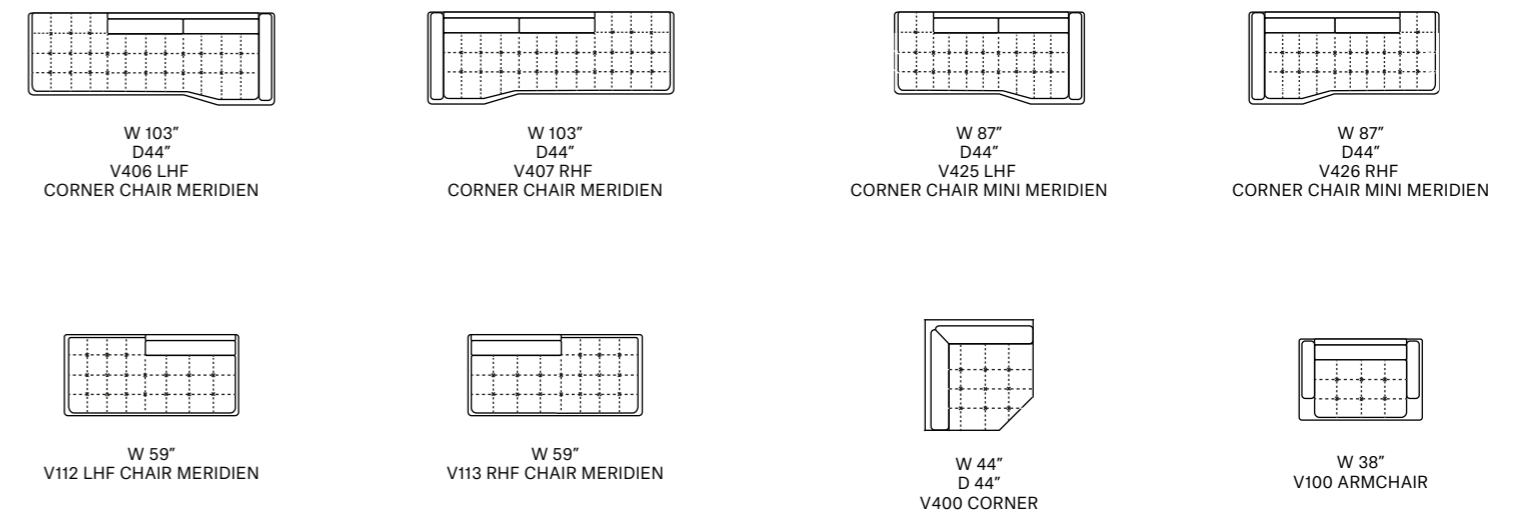

Technical Description

- thick stitch:** Available as option
- structure:** Hardwood frame for extra strenght
- seat/back suspension:** Reinforced elastic webbing
- seat cushion:** High density ecologic open-cell polyurethane foam and memory foam covered with a layer of dacron wadding
- back cushion:** High density ecologic open-cell polyurethane foam covered with a layer of dacron wadding
- removability:** Back and Seat cushions
- mechanisms:** N.A.
- foot option # 1:** Stainless Steel Satin Finish
- foot/base series option # 2:** Stainless Steel Finish
- foot/base series option # 3:** Stainless Steel Bronze Finish
- covering:** Full leather

Foot Finishing Option



Foot Option 1: Stainless Steel Satin Finish



Foot Option 2: Stainless Steel Finish



Foot Option 3: Stainless Steel Bronze Finish

Thin stitch standard



Thick stitch option



LEATHER COLOR SHADE DIFFERENCES: The model upholstered with some Natural leather such as Maya, Moss, Carees and Sensation, could present in some area differences in color tones of about 5%. Such differences are not to be considered defect but an expression of the natural characteristic of the cowhide. The company reserves the right without prior notice to make technical sheets changes and/or materials for quality product improvement. Leather sofas are a handmade product and according to the leather covering selected there could be a measurement tolerance of about 2 inches (cm 5) on each sku.

Morea

A captivating look and essential lines for this full leather sofa with feet available in two finishes. To be chosen according to your mood.



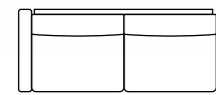

V316 LHF W79"

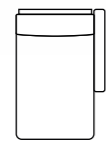

V501 RHF W44"

Morea

Morea has an elegant design and compact size ideal for any urban space. The details on the arms give this model a true sense of charisma.

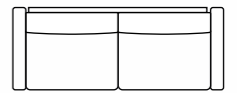

V314 W87"



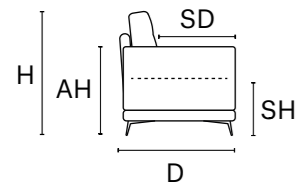

D 39" H 33" AH 28" SH 19" SD 22"

MAXI SEAT (version of the group have the same seat width)

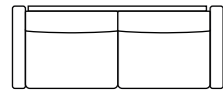

W 87"
V314 SOFA MAXI

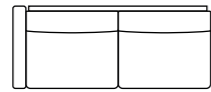

W 79"
V316 LHF SOFA MAXI

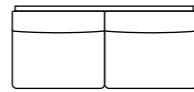

W 72"
V315 SOFA MAXI
ARMLESS

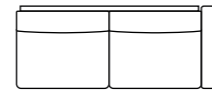

W 79"
V317 RHF SOFA MAXI

MEDIUM SEAT (version of the group have the same seat width)

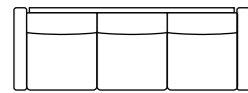

W 101"
V347 SOFA EXTRA
(3 SEAT CUSHIONS)

SMALL SEAT (version of the group have the same seat width)

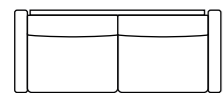

W 72"
V214 LOVESEAT MAXI

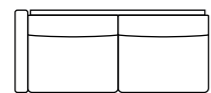

W 65"
V216 LHF LOVESEAT MAXI

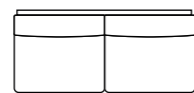

W 57"
V215 LOVESEAT MAXI ARMLESS

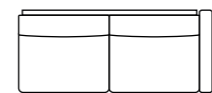

W 65"
V217 RHF LOVESEAT MAXI

X SMALL SEAT (version of the group have the same seat width)

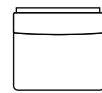

W 24"
V103 ARMLESS CHAIR

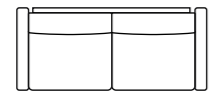

W 65"
V200 LOVESEAT

JOLLY (can be combined with all the version group)

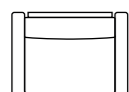

W 40"
V100 ARMCHAIR

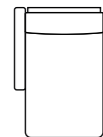

W 44"
D 60"
V500 LHF CHAISE LONGUE

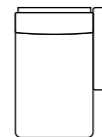

W 44"
D 60"
V501 RHF CHAISE LONGUE

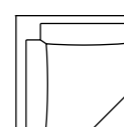

W 45"
D 45"
V400 CORNER



W 24"
D 24"
V600 OTTOMAN



Foot Finishing Option



Foot Option 1:
Stainless Steel Finish



Foot Option 2:
Stainless Steel Bronze Finish

Thin stitch standard



Thick stitch option



Morea

Technical Description

thick stitch: Available as option

structure: Hardwood frame for extra strenght

seat/back suspension: Reinforced elastic webbing

seat/back cushions: High density ecologic open-cell polyurethane foam covered with a layer of dacron wadding

removability: not possible

mechanisms: N.A

foot option 1: Stainless Steel Finish

foot option 2: Stainless Steel Bronze Finish

LEATHER COLOR SHADE DIFFERENCES: The model upholstered with some Natural leather such as Maya, Moss, Carees and Sensation, could present in some area differences in color tones of about 5%. Such differences are not to be considered defect but an expression of the natural characteristic of the cowhide. The company reserves the right without prior notice to make technical sheets changes and/or materials for quality product improvement. Leather sofas are a handmade product and according to the leather covering selected there could be a measurement tolerance of about 2 inches (cm 5) on each sku.

Narciso

Here, style starts with the feet, which are light on the eyes, almost suspended, between the precision of the metal and lightness of the structure.



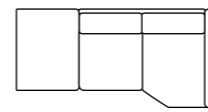

V406 LHF W104"

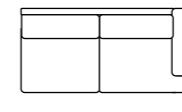

V317 RHF W88"

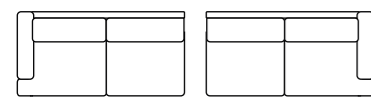

V316 LHF W88"

V317 RHF W88"



V314 W94"

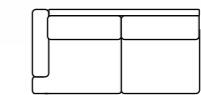

V316 LHF W88"

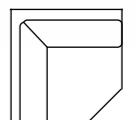

V400 W44"

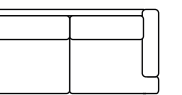

V317 RHF W88"

Narciso

Narciso has a lightweight design with a strong visual impact. This model is characterized by a handmade sophisticated topstitching that offers a surprising touch of elegance. In addition, the seat and back is composed of memory foam and the extreme soft seating comfort perfectly adapts to the body.

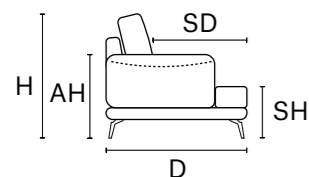

D 39" H 33" AH 23" SH 18" SD 21"

MAXI SEAT (version of the group have the same seat width)

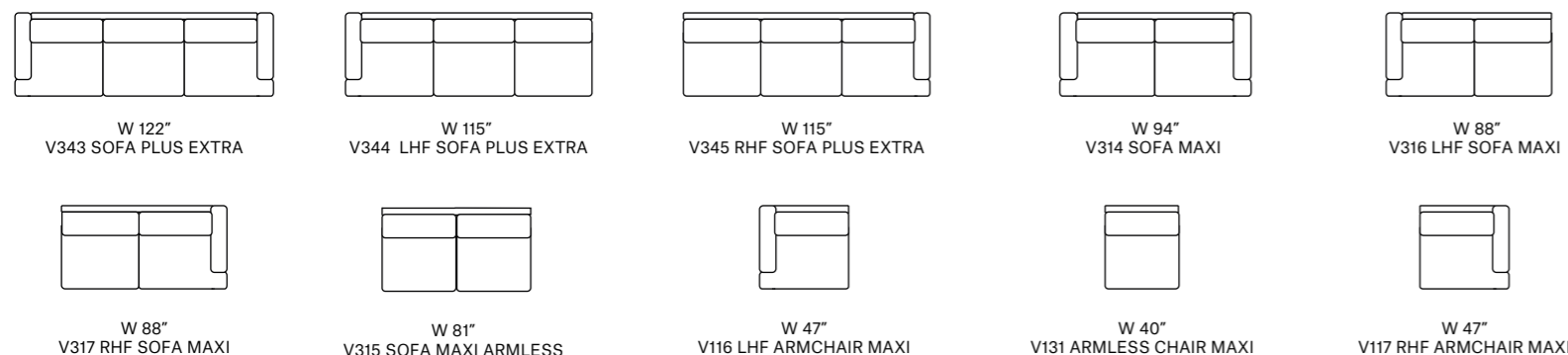

MEDIUM SEAT (version of the group have the same seat width)

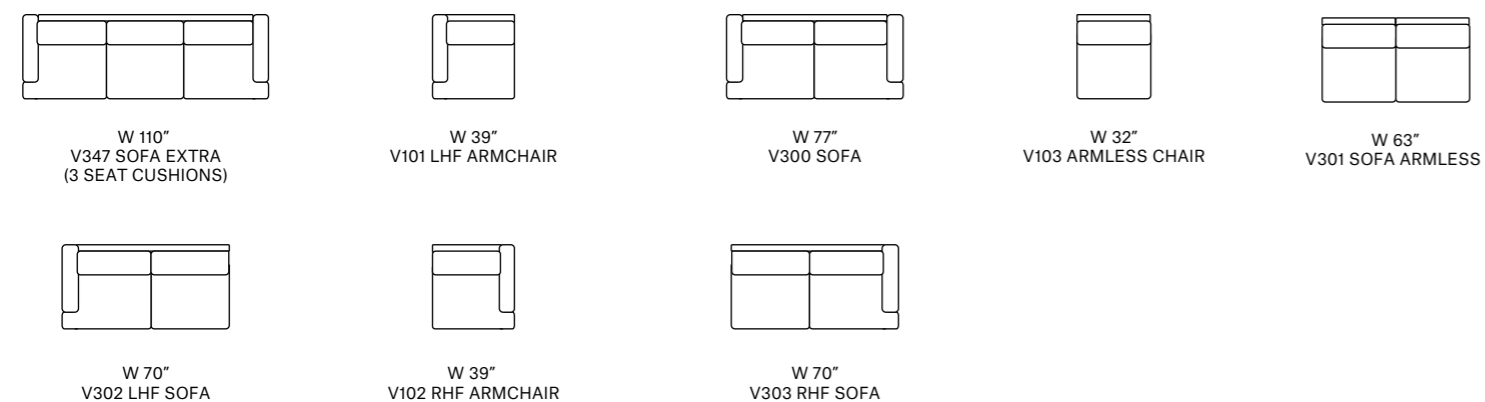

SMALL SEAT (version of the group have the same seat width)

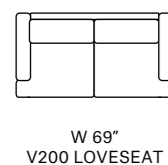

XSMALL SEAT (version of the group have the same seat width)



JOLLY (can be combined with all the version group)

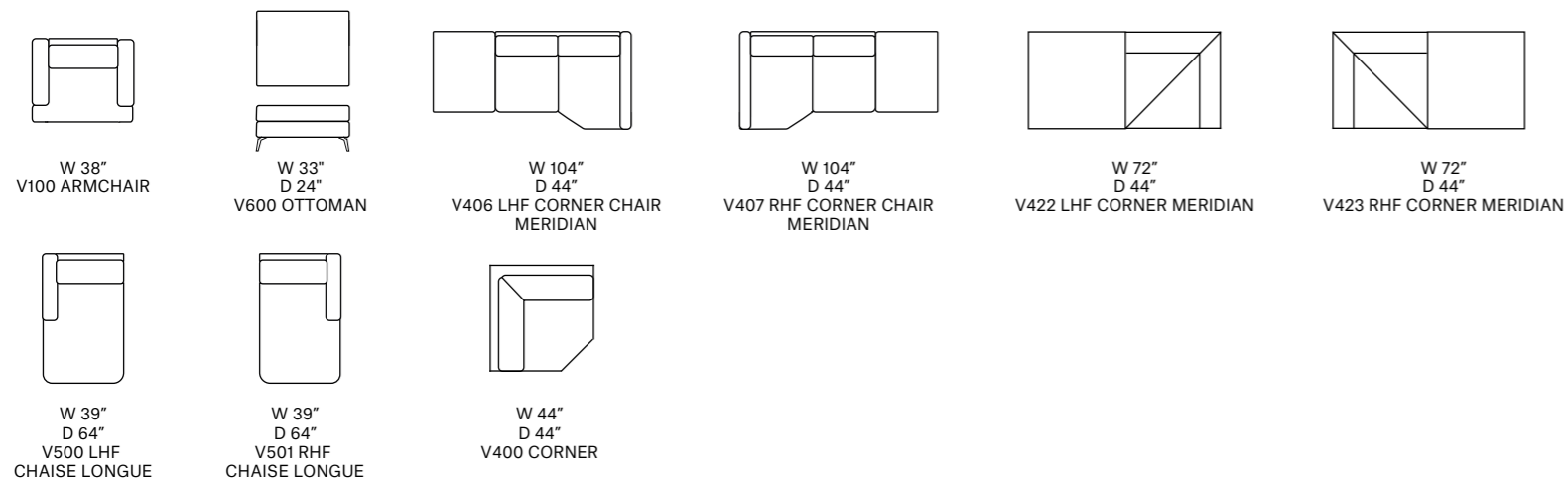

Narciso

Technical Description

decor stitch: "B" Available as option
thick stitch: Available as option
structure: Hardwood frame for extra strenght
back suspension: Reinforced elastic webbing
seat cushion: High density ecologic open-cell polyurethane foam and memory foam covered with a layer of dacron wadding
back cushion: High density ecologic open-cell polyurethane foam covered with a layer of dacron wadding
removability: Back and Seat cushions
mechanisms: N.A.
foot option # 1: Stainless steel sled
foot option # 2: Stainless steel foot
foot option # 3: Stainless Steel Bronze Finish Foot
foot option # 4: Stainless Steel Bronze Finish Sled
covering: Full Leather

Foot Finishing Option



Foot Option 1:
Stainless Steel Sled



Foot Option 2:
Stainless Steel Foot



Foot Option 3:
Stainless Steel Bronze Finish Foot



Foot Option 3:
Stainless Steel Bronze Finish Sled

Thin stitch standard



Thick stitch option



Decor Stich Option



Decor stitch:
Tipe B

LEATHER COLOR SHADE DIFFERENCES: The model upholstered with some Natural leather such as Maya, Moss, Carees and Sensation, could present in some area differences in color tones of about 5%. Such differences are not to be considered defect but an expression of the natural characteristic of the cowhide. The company reserves the right without prior notice to make technical sheets changes and/or materials for quality product improvement. Leather sofas are a handmade product and according to the leather covering selected there could be a measurement tolerance of about 2 inches (cm 5) on each sku.
 REV. 002 DEL 28/10/2020 | Pag. 2 of 2



Plane USA

The perfect synthesis of modularity, craftsmanship, and exclusive design. Its refined character is enhanced by precious details, like the base in wood, enriched by metallic inserts. Exclusive.

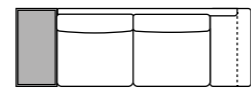

PLANE 9 W 107"

Plane USA

Plane is contemporary and elegant with a minimalist look. The mix of wood and metal makes it a timeless model that adapts to all living spaces with the right mix of classic and contemporary design.



FOOT IN STAINLESS STEEL CHAMPAGNE FINISHING
COFFEE TABLE IN CANALETTO VALNUT

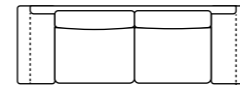

PLANE 2 W 109"

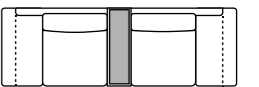

PLANE 5 W 109"

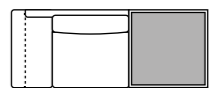

PLANE 65 W 90"



FOOT IN STAINLESS STEEL ASPHALT FINISHING
COFFEE TABLE IN CANALETTO VALNUT

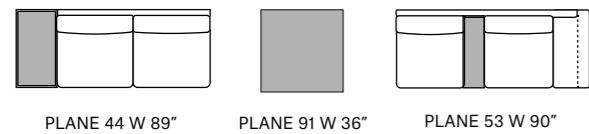

PLANE 44 W 89" PLANE 91 W 36" PLANE 53 W 90"



Option:
Coffee table with drawer



PLANE 44 W 89" PLANE 91 W 36" PLANE 53 W 90"



PLANE 65 W 90" PLANE 53 W 90"

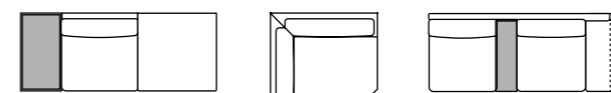

PLANE 71L W 89" PLANE 90 W 48" PLANE 53 W 90"



Plane USA

Technical Description

decor stitch: Not available
thick stitch: Available as option
structure: Hardwood frame for extra strenght
seat cushion: High density ecologic open-cell polyurethane foam and memory foam covered with a layer of dacron wadding
back cushion: High density ecologic open-cell polyurethane foam covered with a layer of dacron wadding
removability : Seat and back cuscions
foot option # 1: stainless steel champagne finish
foot option # 2: stainless steel asphalt finish
wood base option 1 : canaletto walnut
wood base option 2 : Natural oak

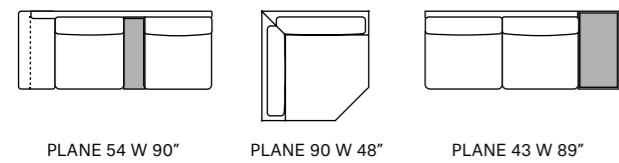

Foot Finishing Option



Thin stitch standard



Thick stitch option



Foot Option 1:
 Stainless Steel
 Champagne Finish



Foot Option 1:
 Canaletto Walnut

Foot Option 2:
 Stainless Steel
 Asphalt Finish



Option 2:
 Natural Oak



Option:
 Coffee table with drawer



**Upon request amrest
 can be reduced 5"**

FOOT IN STAINLESS STEEL CHAMPAGNE FINISHING
 COFFEE TABLE IN NATURAL OAK

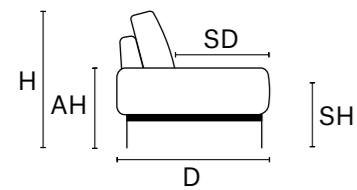

D 38" H 34" AH 20" SH 18" SD 22"

MAXI SEAT (version of the group have the same seat width)

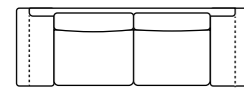

PLANE 2 W 109"
ARMS W 18"

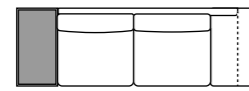

PLANE 9 W 107"
RHF ARM W 18"
LHF WOODEN TABLE W 18"

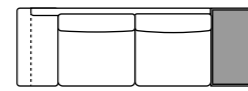

PLANE 10 W 107"
LHF ARM W 18"
RHF WOODEN TABLE W 18"

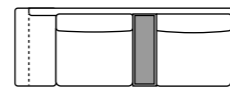

PLANE 22 W 102"
LHF ARM W 18"
MIDDLE WOOD TABLE W 12"

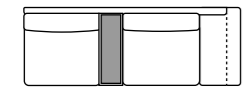

PLANE 21 W 102"
RHF ARM W 18"
MIDDLE WOOD TABLE W 12"

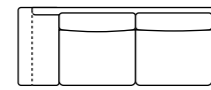

PLANE 38 W 90"
LHF ARM W 18"

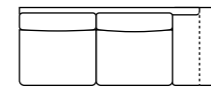

PLANE 37 W 90"
RHF ARM W 18"

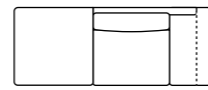

PLANE 60L W 90"
RHF ARM W 18"

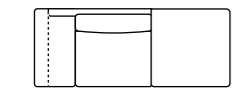

PLANE 59L W 90"
LHF ARM W 18"

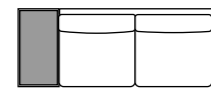

PLANE 44 W 89"
LHF WOOD TABLE W 18"

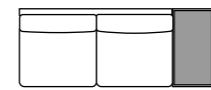

PLANE 43 W 89"
RHF WOOD TABLE W 18"

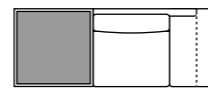

PLANE 66 W 90"
LHF CORNER TABLE
RHF ARM W 18"

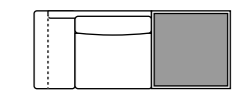

PLANE 65 W 90"
RHF CORNER TABLE
LHF ARM W 18"

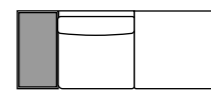

PLANE 71L W 89"
LHF WOOD TABLE W 18"

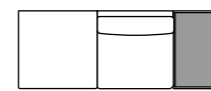

PLANE 72L W 89"
RHF WOOD TABLE W 18"

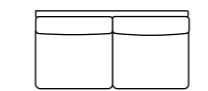

PLANE 79 W 71"

MEDIUM SEAT (version of the group have the same seat width)

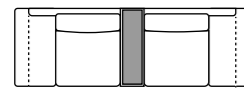

PLANE 5 W 109"
ARMS W 18"
MIDDLE TABLE W 12"

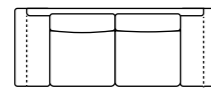

PLANE 29 W 97"
ARMS W 18"
SEAT/BACK CUSHION W 30"

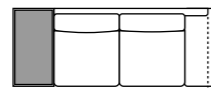

PLANE 33 W 96"
LHF WOOD TABLE W 18"
RHF ARM W 18"

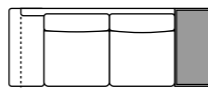

PLANE 34 W 96"
RHF WOOD TABLE W 18"
LHF ARM W 18"

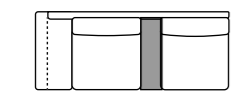

PLANE 54 W 90"
LHF ARM W 18"
MIDDLE WOOD TABLE W 12"

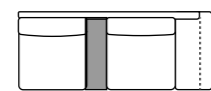

PLANE 53 W 90"
RHF ARM W 18"
MIDDLE WOOD TABLE W 12"

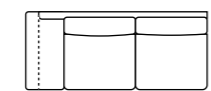

PLANE 76 W 78"
LHF ARM W 18"

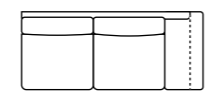

PLANE 75 W 78"
RHF ARM W 18"

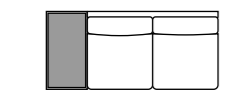

PLANE 83 W 77"
LHF WOOD TABLE W 18"

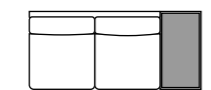

PLANE 82 W 77"
RHF WOOD TABLE W 18"

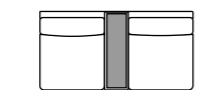

PLANE 84 W 71"
MIDDLE WOOD TABLE W 12"

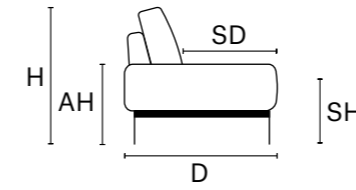

D 38" H 34" AH 20" SH 18" SD 22"

JOLLY (can be combined with all the version group)

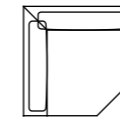

PLANE 90 W 48"
D 48"
CORNER



PLANE 91 W 36"
D 35"
WOODEN TABLE CORNER
FREE STANDING

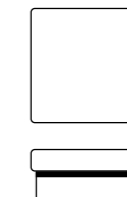

PLANE 92 W 36"
D 35"
BENCH/CORNER
FREE STANDING

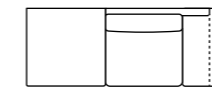

PLANE 60 W 90"
LHF CORNER POUFF (SH20")
RHF ARM W 18"

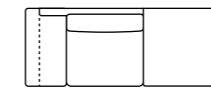

PLANE 59 W 90"
RHF CORNER POUFF (SH20")
LHF ARM W 18"

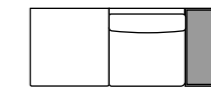

PLANE 72 W 89"
LHF CORNER POUFF (SH 20")
RHF WOOD TABLE W 18"

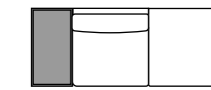

PLANE 71 W 89"
RHF CORNER POUFF (SH 20")
LHF WOOD TABLE W 18"

EXAMPLES OF COMPOSITION

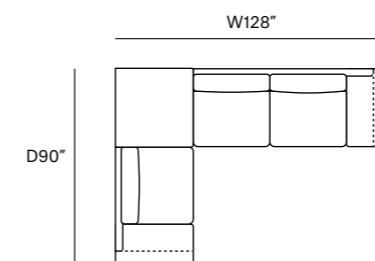

PLANE 59 + PLANE 37

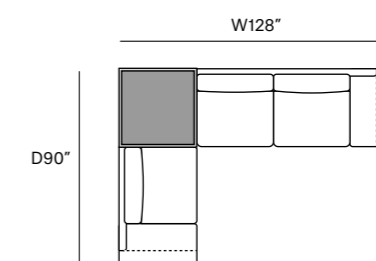

PLANE 65 + PLANE 37

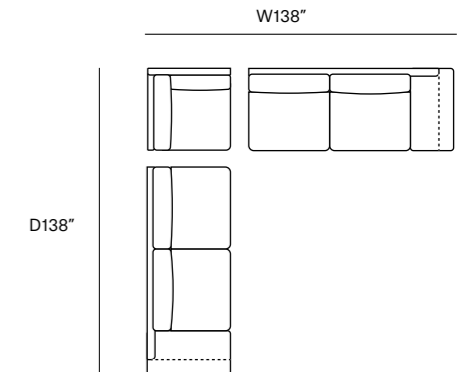

PLANE 38 + PLANE 90 + PLANE 37

LEATHER COLOR SHADE DIFFERENCES: The model upholstered with some Natural leather such as Maya, Moss, Carees and Sensation, could present in some area differences in color tones of about 5%. Such differences are not to be considered defect but an expression of the natural characteristic of the cowhide. The company reserves the right without prior notice to make technical sheets changes and/or materials for quality product improvement. Leather sofas are a handmade product and according to the leather covering selected there could be a measurement tolerance of about 2 inches (cm 5) on each sku.
REV. 002 DEL 28/10/2020 | Pag. 2 of 2

Taormina

Sinuous and elegant, this sofa interprets contemporary living with a versatile and practical system, where the seats, upper and lower backrests fit perfectly together in a succession of soft volumes.



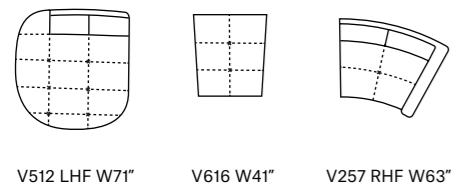

Taormina

Taormina has a curved design with an elegant classic and modern look. The comfortable supporting backrest, tufting on seat and a sartorial arm detail give this model a real craft look. Taormina has a true sense of charisma and would look good in any living space.

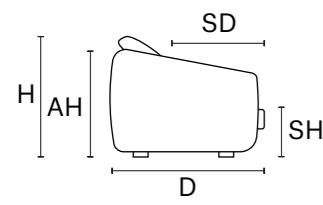

H 37" AH 29" SH 19" SD 22"

STANDARD

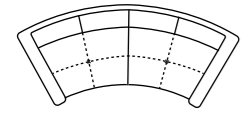

4 SEATER SOFA
V256+V257

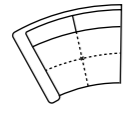

W 63"
D 42"
V256 LHF LOVESEAT CURVED

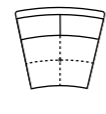

W 59"
D 42"
V255 LOVE SEAT ARMLESS CURVED

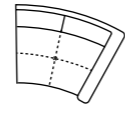

W 63"
D 42"
V257 RHF LOVESEAT CURVED

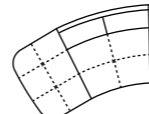

W 83"
D 44"
V248 LHF LOVESEAT MERIDIAN CURVED

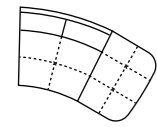

W 83"
D 44"
V249 RHF LOVESEAT MERIDIAN CURVED

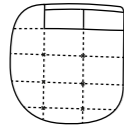

W 71"
D 63"
V512 LHF CHAISE LOUNGE CURVED

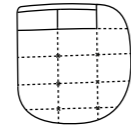

W 71"
D 63"
V513 RHF CHAISE LOUNGE CURVED



W 35"
D 35"
H 19"
V615 POUFF ROUND



W 41"
D 31"
H 19"
V616 POUFF CONSOLLE

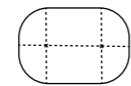

W 43"
D 30"
H 19"
V617 POUFF OVAL

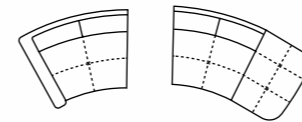

V256 LHF W63" V249 RHF W83"

Thin stitch standard



Thick stitch option



Taormina

Technical Description

- thick stitch:** Available as option instead of the piping
- structure:** Hardwood frame structure for extra strenght
- seat/back suspension:** Reinforced elastic webbing
- seat cushions:** High density ecologic open cell polyurethane foam and memory foam covered with a layer of dracon wadding
- back cushions:** High density ecologic open cell polyurethane foam covered with a layer of dracon wadding
- removability:** Seat and back cushions
- foot:** Not visible



LEATHER COLOR SHADE DIFFERENCES: The model upholstered with some Natural leather such as Maya, Moss, Carees and Sensation, could present in some area differences in color tones of about 5%. Such differences are not to be considered defect but an expression of the natural characteristic of the cowhide. The company reserves the right without prior notice to make technical sheets changes and/or materials for quality product improvement. Leather sofas are a handmade product and according to the leather covering selected there could be a measurement tolerance of about 2 inches (cm 5) on each sku.
REV. 002 DEL 28/10/2020 | Pag. 2 of 2

Tivoli

Cultured and measured design make this sofa a timeless element. Adaptable to any living room thanks to the modular seating, it offers the space ever-new configurations.



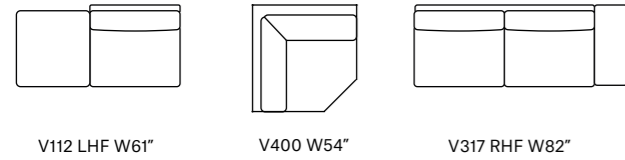

Tivoli

Tivoli becomes the protagonist of living spaces because it is characterized by essential lines and modern design. In addition, the seat and back filled with the right combination of memory foam offers an extreme soft seating comfort which perfectly adapts to the body.

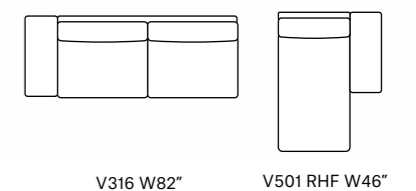
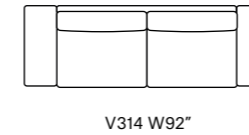
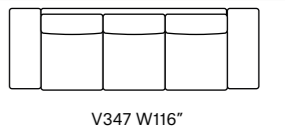

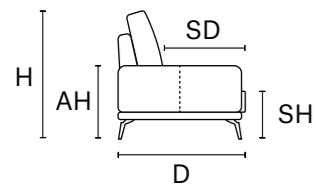

D 40" H 33" AH 22" SH 18" SD 22"

MAXI SEAT (version of the group have the same seat width)

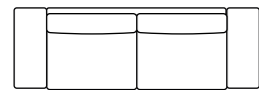

W 92"
V314 SOFA MAXI

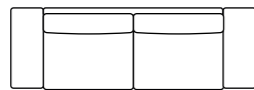

W 82"
V316 LHF SOFA MAXI

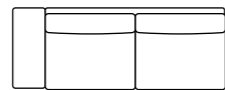

W 72"
V315 SOFA MAXI ARMLESS

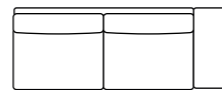

W 82"
V317 RHF SOFA MAXI

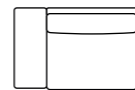

W 46"
V116 LHF ARMCHAIR MAXI

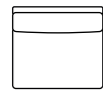

W 36"
V131 ARMLESS CHAIR MAXI

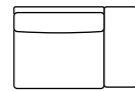

W 46"
V117 RHF ARMCHAIR MAXI

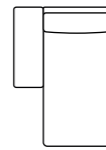

W 46"
D 66"
V500 LHF CHAISE LONGUE

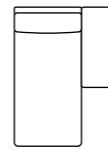

W 46"
D 66"
V501 RHF CHAISE LONGUE

MEDIUM SEAT (version of the group have the same seat width)

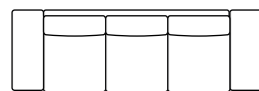

W 116"
V347 SOFA EXTRA (3 CUSHIONS)

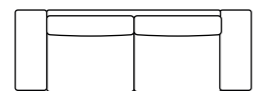

W 84"
V300 SOFA

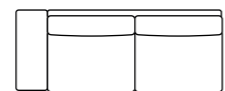

W 74"
V302 LHF SOFA

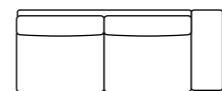

W 74"
V303 RHF SOFA

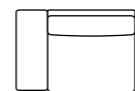

W 42"
V114 LHF ARMCHAIR MEDIUM

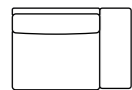

W 42"
V115 RHF ARMCHAIR MEDIUM

SMALL SEAT (version of the group have the same seat width)

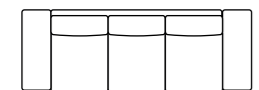

W 103"
V242 LOVESEAT MAXI EXTRA

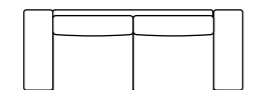

W 76"
V214 LOVESEAT MAXI

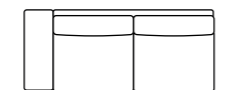

W 66"
V216 LHF LOVESEAT MAXI

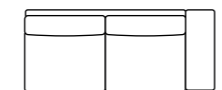

W 66"
V217 RHF LOVESEAT MAXI

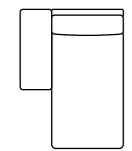

W 38"
MD 66"
V504 LHF CHAISE LONGUE MINI

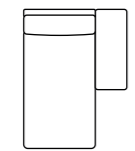

W 38"
MD 66"
V505 RHF CHAISE LONGUE MINI

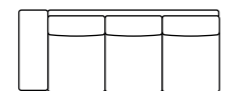

W 94"
V243 LHF LOVESEAT MAXI EXTRA

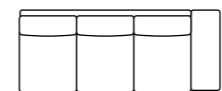

W 94"
V244 RHF LOVESEAT MAXI EXTRA

JOLLY (can be combined with all the version group)

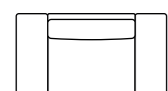

W 45"
V100 ARMCHAIR

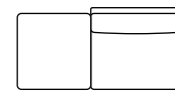

W 61"
V112 LHF CHAIR MERIDIAN

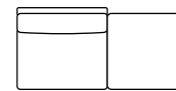

W 61"
V113 RHF CHAIR MERIDIAN

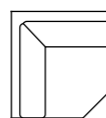

W 54"
D 54"
V400 CORNER

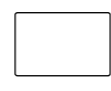

W 35"
D 24"
V600 OTTOMAN



W 35"
D 35"
V601 BENCH

Tivoli

Technical Description

thick stitch: Available as option

structure: Hardwood frame with metal insert for extra strenght

seat/back suspension: Reinforced elastic webbing

seat cushion: High density ecologic open-cell polyurethane foam and memory foam covered with a layer of dacron wadding

back cushion: High density ecologic open-cell polyurethane foam covered with a layer of dacron wadding

removability: Seat and back cuscion

seat/back cushion mechanism: N.A.

foot option # 1: Stainless steel finish

foot option # 2: Stainless steel bronze finish

Thin stitich standard



Thick stitch option



Foot Finishing Option



Foot Option 1:
Stainless Steel Finish



Foot Option 2:
Stainless Steel Bronze Finish



LEATHER COLOR SHADE DIFFERENCES: The model upholstered with some Natural leather such as Maya, Moss, Carees and Sensation, could present in some area differences in color tones of about 5%. Such differences are not to be considered defect but an expression of the natural characteristic of the cowhide. The company reserves the right without prior notice to make technical sheets changes and/or materials for quality product improvement. Leather sofas are a handmade product and according to the leather covering selected there could be a measurement tollerance of about 2 inches (cm 5) on each sku.

REV. 002 DEL 28/10/2020 | Pag. 2 of 2

Trendy

The balanced forms and attention to detail give the Trendy sofa optimal proportions. The padding is soft and the backrests embracing. Comfortable and comforting.



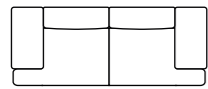

V314 W89"

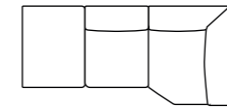

V406 LHF W106"

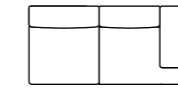

V317 RHF W78"

Trendy

Trendy is austere and elegant with a minimalist look that sits perfectly in a modern environment but also adapts to spaces with the right mix of classic and contemporary design.

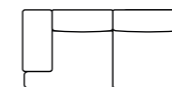

V316 LHF W78"

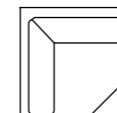

V414 W48"

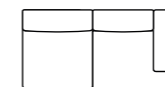

V317 RHF W78"



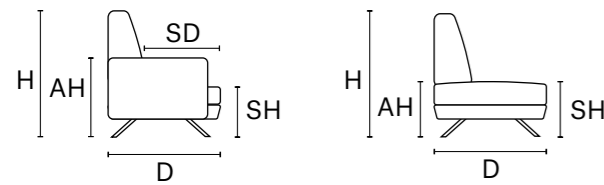

D 40" H 32" AH 22" SH 18" SD 24"

MAXI SEAT (version of the group have the same seat width)

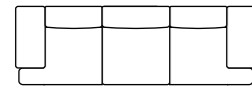

W 122"
V342 SOFA MAXI EXTRA

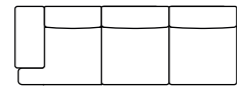

W 111"
V349 LHF SOFA MAXI EXTRA

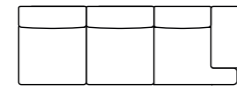

W 111"
V350 RHF SOFA MAXI EXTRA

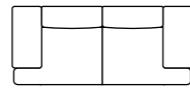

W 89"
V314" SOFA MAXI

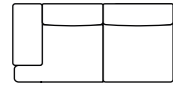

W 78"
V316 LHF SOFA MAXI

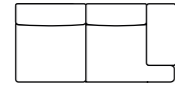

W 78"
V317 RHF SOFA MAXI

MEDIUM SEAT (version of the group have the same seat width)

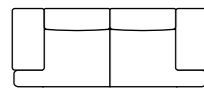

W 100"
V347 SOFA EXTRA
(2 SEAT CUSHIONS)

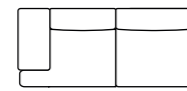

W 90"
V351 LHF SOFA EXTRA
(2 SEAT CUSHIONS)

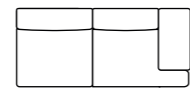

W 90"
V352 RHF SOFA EXTRA
(2 SEAT CUSHIONS)

SMALL SEAT (version of the group have the same seat width)

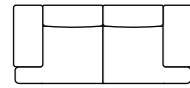

W 77"
V214 LOVESEAT MAXI

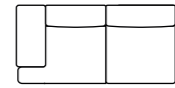

W 66"
V216 LHF LOVESEAT MAXI

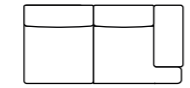

W 66"
V217 RHF LOVESEAT MAXI

XSMALL SEAT (version of the group have the same seat width)

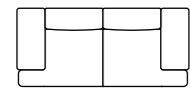

W 69"
V200 LOVESEAT

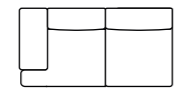

W 58"
V202 LHF LOVESEAT

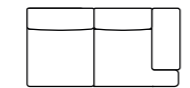

W 58"
V203 RHF LOVESEAT

JOLLY (can be combined with all the version group)

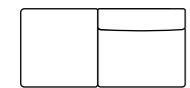

W 57"
V112 LHF CHAIR MERIDIAN



W 57"
V113 RHF CHAIR MERIDIAN

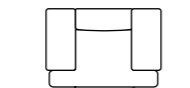

W 45"
V100 ARMCHAIR

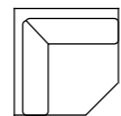

W 48"
D 48"
V414 SQUARE CORNER

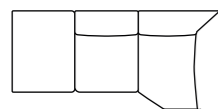

W 106"
D 48"
V406 LHF CORNER
CHAIR MERIDIAN

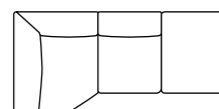

W 106"
D 48"
V407 RHF CORNER
CHAIR MERIDIAN



W 35"
D 28"
V600 OTTOMAN



Foot Finishing Option



Foot Option 1:
Stainless Steel Finish



Foot Option 2:
Stainless Steel Bronze Finish

Thin stitch standard



Thick stitch option



Decor Stich Option



Decor stitch:
Tipe C

Trendy

Technical Description

- thick stitch:** available as option
- decor stitch:** "C" available as option
- structure:** hardwood frame with metal insert for extra strength
- seat/back suspension:** reinforced elastic webbing
- seat cushion:** High density ecologic open-cell polyurethane foam and memory foam covered with a layer of dacron wadding
- back cushion:** High density ecologic open-cell polyurethane foam covered with a layer of dacron wadding
- removability:** Only seat cushions
- mechanisms:** N.A.
- foot option # 1:** Stainless steel finish
- foot option # 2:** Stainless steel bronze finish

LEATHER COLOR SHADE DIFFERENCES: The model upholstered with some Natural leather such as Maya, Moss, Carees and Sensation, could present in some area differences in color tones of about 5%. Such differences are not to be considered defect but an expression of the natural characteristic of the cowhide. The company reserves the right without prior notice to make technical sheets changes and/or materials for quality product improvement. Leather sofas are a handmade product and according to the leather covering selected there could be a measurement tolerance of about 2 inches (cm 5) on each sku.
REV. 002 DEL 28/10/2020 | Pag. 2 of 2



Pag. 136
ARCADIA



Pag. 170
JERRY



Pag. 142
ATHOS



Pag. 176
KAOS



Pag. 148
BACCO



Pag. 180
LORY



Pag. 152
ERMES



Pag. 186
LUCY



Pag. 158
FOCUS



Pag. 192
MEDUSA



Pag. 164
IRIDE



Pag. 198
MILLENIUM

POWER MOTION SOFAS & SECTIONALS

To each their own comfort. That's why our sofas include mechanisms and features that cater to your idea of comfort. You can shape and adjust every part of the sofa as needed: seats, backrests, footrests and headrests, all choosing the covering you most prefer, always in the certainty that you're bringing home a product handcrafted by our craftsmen, stitch after stitch with decorative quilting, and feet in stainless steel on bronze finish. Whatever your idea of style or life, Bracci is the sofa that completes it.



Pag. 204
MORFEO



Pag. 228
STYLE



Pag. 210
OLIMPO



Pag. 234
TONY



Pag. 216
PAKY



Pag. 240
VOGUE



Pag. 222
SMART



Pag. 246
ZEUS

Arcadia

A contemporary reinterpretation of precious quilted workmanship, accompanied by all the convenience of the relaxation mechanism that moves the footrest and headrest for extreme comfort.

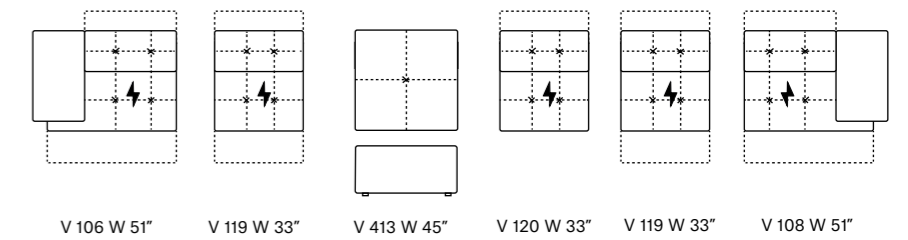
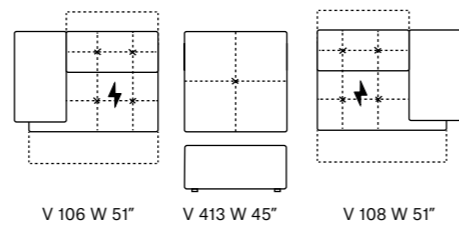

Arcadia

Is a power motion model with wide seats featuring topstitching on the seat and back cushions. The armrest exterior is skillfully designed to create a break with the main structure. Arcadia is equipped with a state of the art power mechanism and touchpad that individually controls headrest and footrest allowing maximum comfort and support for your head, back and legs. This model is available with two seat width options and it's modularity allows to make any size sofa or sectional.

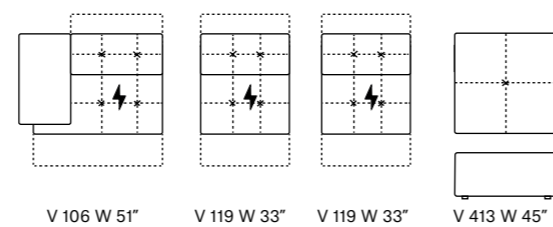

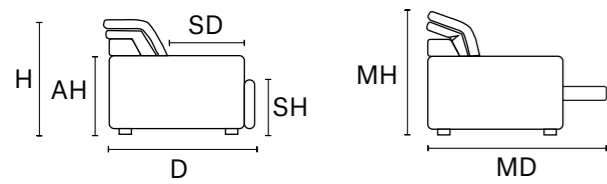

D 43" | MD 62" | H 32" | AH 22" | SH 17" | SD 22" | MH 40"

MAXI SEAT (version of the group have the same seat width)

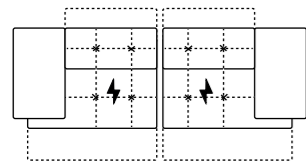

W 102"
V106 + V108 SOFA MAXI RCL
ELECTRIC HEAD- FOOT

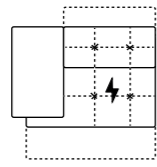

W 51"
V106 LHF ARMCHAIR MAXI RECLINER
HEAD AND FOOT
V121 LHF ARMCHAIR MAXI
ONLY ELECTRIC HEADREST

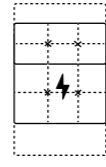

W 33"
V119 ARMLESS CHAIR
MAXI RECLINER
ELECTRIC HEAD AND FOOT
V120 ARMLESS CHAIR MAXI ONLY
ELECTRIC HEADREST

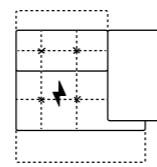

W 51"
V108 RHF ARMCHAIR MAXI RECLINER
HEAD AND FOOT
V122 RHF ARMCHAIR MAXI
ONLY ELECTRIC HEADREST

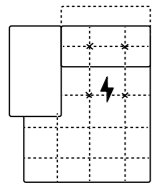

W 51"
D 68"
SD 51"
V506 LHF CHAISE LONGUE MAXI
ONLY ELECTRIC HEADREST

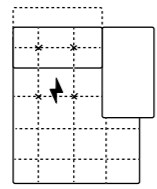

W 51"
D 68"
SD 51"
V507 RHF CHAISE LONGUE MAXI
ONLY ELECTRIC HEADREST

MINI SEAT (version of the group have the same seat width)

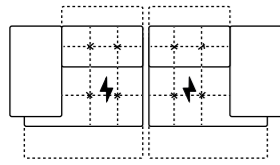

W 81"
V125 + V126
LOVESEAT MINI RCL
ELECTRIC HEAD- FOOT

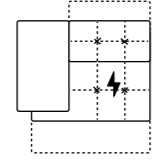

W 41"
V125 LHF ARMCHAIR MINI RECLINER
HEAD AND FOOT
V127 LHF ARMCHAIR MINI
ONLY ELECTRIC HEADREST

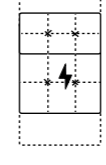

W 23"
V123 ARMLESS CHAIR MINI RECLINER
ELECTRIC HEAD AND FOOT
V124 ARMLESS CHAIR MINI ONLY
ELECTRIC HEADREST

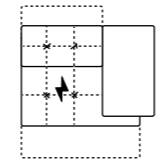

W 41"
V126 RHF ARMCHAIR MINI RECLINER
HEAD AND FOOT
V128 RHF ARMCHAIR MINI
ONLY ELECTRIC HEADREST

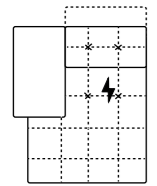

W 41"
D 68"
SD 51"
V508 LHF CHAISE LONGUE MINI
ONLY ELECTRIC HEADREST

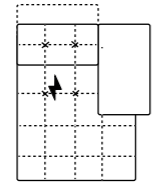

W 41"
D 68"
SD 51"
V509 RHF CHAISE LONGUE MINI
ONLY ELECTRIC HEADREST

JOLLY (can be combined with all the version group)

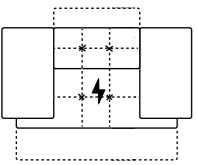

W 48"
V104 ARMCHAIR RECLINER
ELECTRIC HEAD AND FOOT
V 150 ARMCHAIR
ONLY ELECTRIC HEADREST

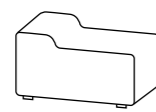

W 20"
H 21"
V621 CONSOLLE STRAIGHT

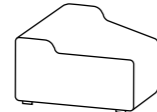

W 13"
MW 20"
H 21"
V620 CONSOLLE ANGLE

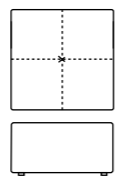

W 45"
D 45"
H 21"
V413 CORNER OTTOMAN

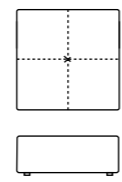

W 45"
D 45"
H 17"
V601 SQUARE OTTOMAN

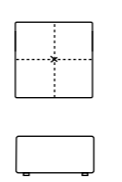

W 33"
D 33"
H 17"
V600 OTTOMAN

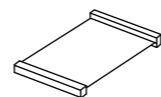

V 701 TRAY CONSOLE



Foot Finishing Option



Foot Option 1:
Stainless Steel Finish base



Foot Option 2:
Stainless Steel Bronze Finish

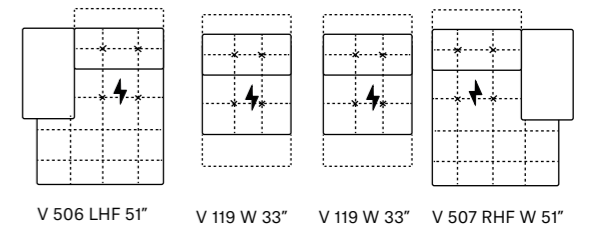

V 506 LHF 51" V 119 W 33" V 119 W 33" V 507 RHF W 51"

Thin stitch standard



Thick stitch option

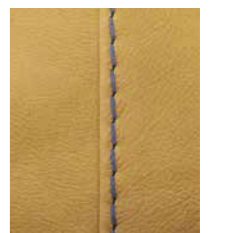

Arcadia

Technical Description

- thick stitch:** Available as option
- structure:** Hardwood frame for extra strenght
- seat/back suspension:** Reinforced elastic webbing
- seat/back cushions:** High density Ecologic open-cell polyurethane foam covered with a layer of dacron wadding
- removability:** Not possible
- mechanisms:** Each seat has two separate motors, one for the headrest and one for the footrest
- base option # 1:** Stainless Steel Finish base
- base option # 2:** Stainless Steel Bronze Finish
- usb:** Available as option
- battery pack:** Available as option

LEATHER COLOR SHADE DIFFERENCES: The model upholstered with some Natural leather such as Maya, Moss, Carees and Sensation, could present in some area differences in color tones of about 5%. Such differences are not to be considered defect but an expression of the natural characteristic of the cowhide. The company reserves the right without prior notice to make technical sheets changes and/or materials for quality product improvement. Leather sofas are a handmade product and according to the leather covering selected there could be a measurement tolerance of about 2 inches (cm 5) on each sku.

Athos

Encompassing. This is the feeling Athos leaves you with. Spectacularly finished and equipped with internal technology to adapt the comfort to your needs, it is padded with the best polyurethane and finished with high-quality primary materials. All you need to do is let go.



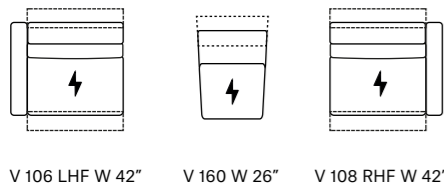

V 106 LHF W 42" V 160 W 26" V 108 RHF W 42"

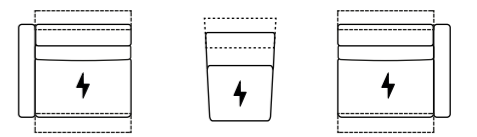

V 106 LHF W 42" V 160 W 26" V 108 RHF W 42"



Athos

Athos is a power motion with a minimalist design that easily adapts to all living spaces. Athos is equipped with a state-of-the-art power mechanism and touchpad that individually controls the headrest and footrest allowing maximum comfort and support for your head, back, and legs even for the tallest people. This model is available with two seat width options and its modularity allows to make any size sofa or sectional.

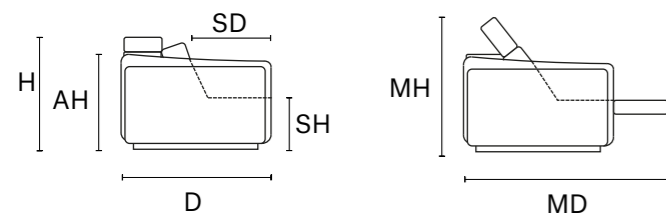

D 44" MD 71" H 35" AH 26" SH 19" SD 22" MH 41"

MAXI SEAT (version of the group have the same seat width)

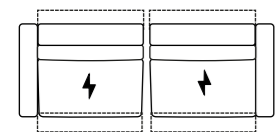

W 83"
V 106 + V108 SOFA MAXI RCL
ELECTRIC HEAD-FOOT

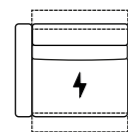

W 42"
V106 LHF ARMCHAIR MAXI RECLINER
ELECTRIC HEAD AND FOOT
V121 LHF ARMCHAIR MAXI
ONLY ELECTRIC HEADREST

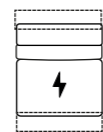

W 33"
V119 ARMLESS CHAIR MAXI RECLINER
ELECTRIC HEAD AND FOOT
V120 ARMLESS CHAIR MAXI
ONLY ELECTRIC HEADREST

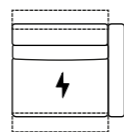

W 42"
V108 RHF ARMCHAIR MAXI RECLINER
ELECTRIC HEAD AND FOOT
V122 RHF ARMCHAIR MAXI
ONLY ELECTRIC HEADREST

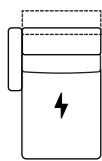

W 42"
D 69"
V 506 LHF CHAISE LOUNGE MAXI
ONLY ELECTRIC HEADREST

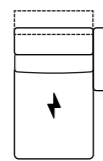

W 42"
D 69"
V 507 RHF CHAISE LOUNGE MAXI
ONLY ELECTRIC HEADREST

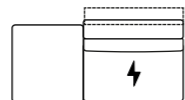

W 61"
V 166 LHF CHAIR MAXI MERIDIAN
ONLY ELECTRIC HEADREST

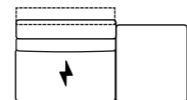

W 61"
V 167 RHF CHAIR MAXI MERIDIAN
ONLY ELECTRIC HEADREST

MINI SEAT (version of the group have the same seat width)

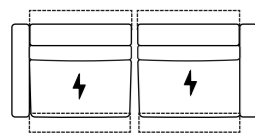

W 72"
V 125 + V 126 LOVESEAT MINI RCL
ELECTRIC HEAD-FOOT

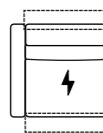

W 36"
V125 LHF ARMCHAIR MINI RECLINER
ELECTRIC HEAD AND FOOT
V127 LHF ARMCHAIR MINI
ONLY ELECTRIC HEADREST

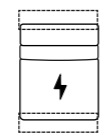

W 28"
V123 ARMLESS CHAIR MINI RECLINER
ELECTRIC HEAD AND FOOT
V124 ARMLESS CHAIR MINI
ONLY ELECTRIC HEADREST

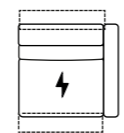

W 36"
V126 RHF ARMCHAIR MINI RECLINER
ELECTRIC HEAD AND FOOT
V128 RHF ARMCHAIR MINI
ONLY ELECTRIC HEADREST

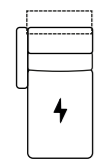

W 36"
D 69"
V 508 LHF
CHAISE LOUNGE MINI
ONLY ELECTRIC HEADREST

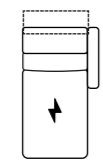

W 36"
D 69"
V 509 RHF
CHAISE LOUNGE MINI
ONLY ELECTRIC HEADREST

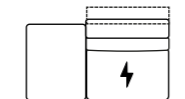

W 56"
V168 LHF CHAIR MINI MERIDIAN
ONLY ELECTRIC HEADREST

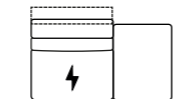

W 56"
V169 RHF CHAIR MINI MERIDIAN
ONLY ELECTRIC HEADREST

JOLLY (can be combined with all the version group)

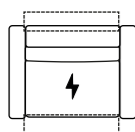

W 44"
V104 ARMCHAIR RECLINER
ELECTRIC HEAD AND FOOT
V 150 ARMCHAIR
ONLY ELECTRIC HEADREST

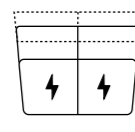

W 52"
MW 65"
V 251 LOVESEAT ARMLESS ANGLED
ONLY ELECTRIC HEADREST

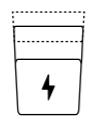

W 26"
MW 39"
V 160 ARMLESS CHAIR MAXI ANGLED
ONLY ELECTRIC HEADREST

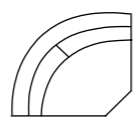

W 54"
D 54"
V 400 ROUND CORNER

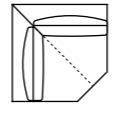

W 54"
D 54"
V 414 SQUARE CORNER

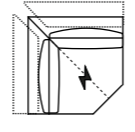

W 54"
D 54"
V 415 SQUARE CORNER
ELECTRIC HEADREST

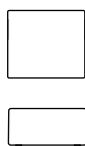

W 35"
D 30"
V600 OTTOMAN

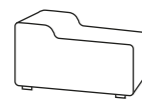

W 9"
H 22"
MH 26"
V613 CONSOLLE MINI STRAIGHT

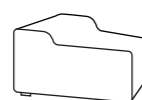

W 9"
MW 16"
H 22"
MH 26"
V614 CONSOLLE MINI ANGLE

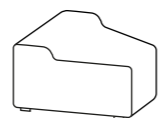

W 13"
MW 20"
H 22"
MH 26"
V620 CONSOLLE ANGLE



W 20"
H 22"
MH 26"
V621 CONSOLLE STRAIGHT

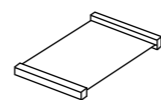

V701 TRAY CONSOLE



Foot Finishing Option



Foot Option 1:
Stainless Steel sled



Foot Option 2:
Stainless Steel Bronze Finish sled

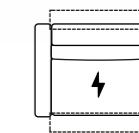

V 104 W 44"

Thin stitch standard



Thick stitch option



Athos

Technical Description

- thick stitch:** Available as option
- structure:** Hardwood frame for extra strength
- spring system:** Reinforced elastic webbing
- seat/back cushion:** High density ecologic open-cell polyurethane foam covered with a layer of dacron wedding
- removability:** Not available
- battery pack:** Available as option
- usb:** Available as an option
- tray:** Wooden matt black finish, upon request on console
- base option # 1:** Stainless Steel sled
- base option # 2:** Metal base bronze finish sled

LEATHER COLOR SHADE DIFFERENCES: The model upholstered with some Natural leather such as Maya, Moss, Carees and Sensation, could present in some area differences in color tones of about 5%. Such differences are not to be considered defect but an expression of the natural characteristic of the cowhide. The company reserves the right without prior notice to make technical sheets changes and/or materials for quality product improvement. Leather sofas are a handmade product and according to the leather covering selected there could be a measurement tolerance of about 2 inches (cm 5) on each sku.
REV. 002 DEL 28/10/2020 | Pag. 2 of 2

Bacco

A welcoming sofa with comfortable armrests and even more comfortable occasional tables. Its motion system guarantees personalized relaxation and the USB port allows convenient recharging of your devices. Divine.

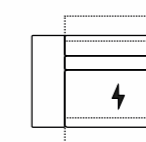

V106 LHF W45"

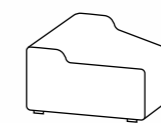

V620 W13"

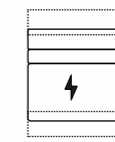

V119 W33"

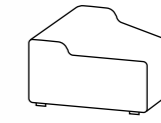

V620 W13"

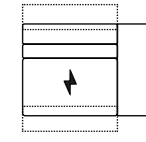

V108 RHF W45"

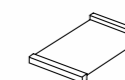

V701 TRAY CONSOLE

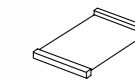

V701 TRAY CONSOLE

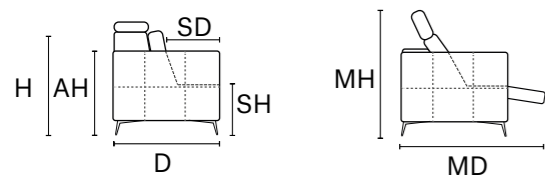

D 44" MD 69" H 34" AH 26" SH 19" SD 22" MH 41"

MAXI SEAT (version of the group have the same seat width)

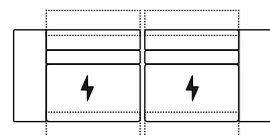

W 91"
V106 + V108 SOFA MAXI RCL ELECTRIC HEAD - FOOT

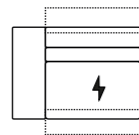

W 45"
V106 LHF ARMCHAIR MAXI RECLINER ELECTRIC HEAD AND FOOT V 121 LHF ARMCHAIR MAXI ONLY ELECTRIC HEADREST

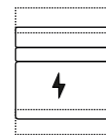

W 33"
V119 ARMLESS CHAIR MAXI RECLINER ELECTRIC HEAD AND FOOT V 120 ARMLESS CHAIR MAXI ONLY ELECTRIC HEADREST

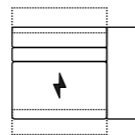

W 45"
V108 RHF ARMCHAIR MAXI RECLINER ELECTRIC HEAD AND FOOT V 122 RHF ARMCHAIR MAXI ONLY ELECTRIC HEADREST

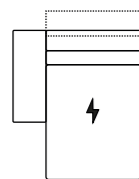

W 45"
D 69"
V 506 LHF CHAISE LONGUE MAXI ONLY ELECTRIC HEADREST

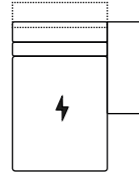

W 45"
D 69"
V 507 RHF CHAISE LONGUE MAXI ONLY ELECTRIC HEADREST

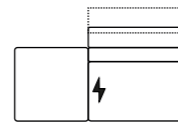

W 61"
V 166 LHF CHAIR MAXI MERIDIAN ONLY ELECTRIC HEADREST

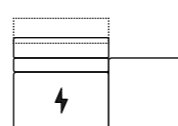

W 61"
V 167 RHF CHAIR MAXI MERIDIAN ONLY ELECTRIC HEADREST

MINI SEAT (version of the group have the same seat width)

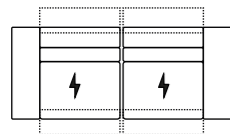

W 79"
V125 + V126 LOVE SEAT MINI RCL ELECTRIC HEAD - FOOT

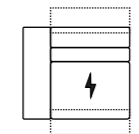

W 39"
V125 LHF ARMCHAIR MINI RECLINER ELECTRIC HEAD AND FOOT V 127 LHF ARMCHAIR MINI ONLY ELECTRIC HEADREST

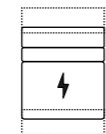

W 28"
V123 ARMLESS CHAIR MINI RECLINER ELECTRIC HEAD AND FOOT V 124 ARMLESS CHAIR MINI ONLY ELECTRIC HEADREST

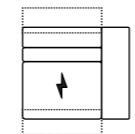

W 39"
V126 RHF ARMCHAIR MINI RECLINER ELECTRIC HEAD AND FOOT V 128 RHF ARMCHAIR MINI ONLY ELECTRIC HEADREST

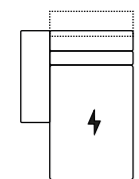

W 39"
D 69"
V 508 LHF CHAISE LONGUE MINI ONLY ELECTRIC HEADREST

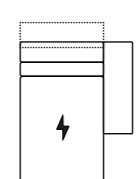

W 39"
D 69"
V 509 RHF CHAISE LONGUE MINI ONLY ELECTRIC HEADREST

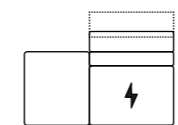

W 56"
V 168 LHF CHAIR MINI MERIDIAN ONLY ELECTRIC HEADREST

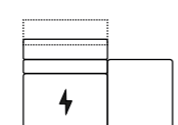

W 56"
V 169 RHF CHAIR MINI MERIDIAN ONLY ELECTRIC HEADREST

JOLLY (can be combined with all the version group)

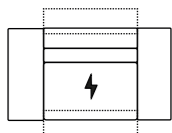

W 51"
V 104 ARMCHAIR RECLINER ELECTRIC HEAD AND FOOT V 150 ARMCHAIR ONLY ELECTRIC HEADREST

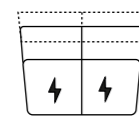

W 52"
MW 65"
V 251 LOVESEAT ARMLESS ANGLED ONLY ELECTRIC HEADREST

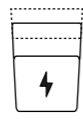

W 26"
MW 39"
V 160 ARMLESS CHAIR MAXI ANGLED ONLY ELECTRIC HEADREST



W 54"
D 54"
V400 ROUND CORNER

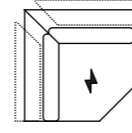

W 54"
D 54"
V415 SQUARE CORNER ELECTRIC HEADREST

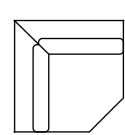

W 54"
D 54"
V414 SQUARE CORNER



W 35"
D 30"
H 19"
V 620 OTTOMAN

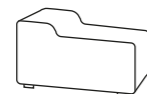

W 9"
H 22"
MH 26"
V613 CONSOLLE MINI STRAIGHT



W 9"
MW 16"
H 22"
MH 26"

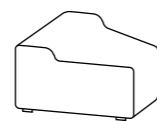

W 13"
MW 20"
H 22"
MH 26"

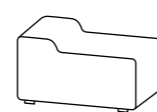

W 20"
H 22"
MH 26"
V 621 CONSOLLE STRAIGHT

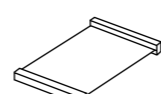

V701 TRAY CONSOLE



Bacco

Bacco is a power motion with a transitional modern look which easily adapts to all living spaces. Bacco is equipped with a state of the art power mechanism and touchpad that individually controls headrest and footrest allowing maximum comfort and support for your head, back and legs even for the tallest people. This model is available with two seat width options and it's modularity allows to make any size sofa or sectional.

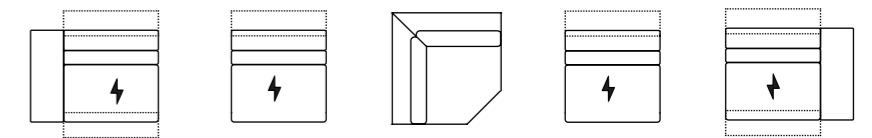

V106 LHF W45" V120 W33" V414 W54" V120 W33" V108 RHF W45"

Foot Finishing Option

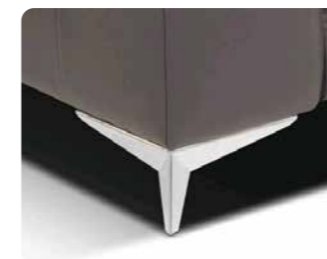

Foot Option 1:
Stainless Steel Finish



Foot Option 2:
Stainless Steel Bronze Finish



Foot Option 3:
Wood Walnut

Thin stitch standard



Thick stitch option



Technical Description

- thick stitch:** Available as option
- structure:** Hardwood frame for extra strength
- seat/back suspension:** Reinforced elastic webbing
- seat/back cushions:** High Density ecologic open cell polyurethane foam covered with a layer of dacron wadding
- removability:** Not possible
- mechanisms :** Each seat has two separate motors, one for the headrest and one for the footrest
- battery packs:** Available as option
- usb port:** Available as option
- tray:** Wooden matt black finish is available upon request on console
- foot option 1:** Stainless Steel Finish
- foot option 2:** Stainless Steel Bronze Finish
- foot option 3:** Wood walnut



Ermes

Technological soul and handcrafted finishes. This sofa brings personality and function into the same room, allowing you to choose the ideal covering and feet from among the different finishes.



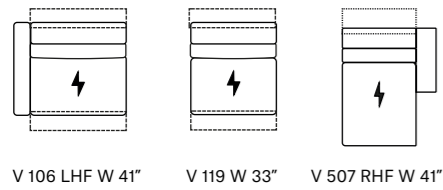

V 106 LHF W 41" V 119 W 33" V 507 RHF W 41"

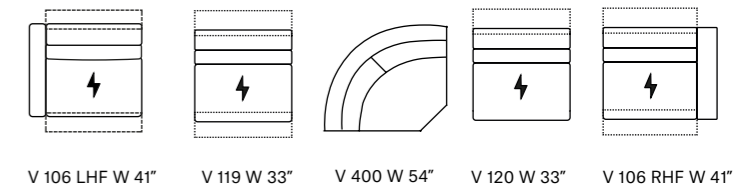

V 106 LHF W 41" V 119 W 33" V 400 W 54" V 120 W 33" V 106 RHF W 41"

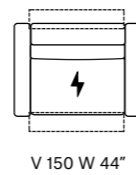

V 150 W 44"



Ermes

Ermes is a power motion with a sophisticated thin arm that easily adapts to all living spaces. Ermes is equipped with a state of the art power mechanism and touchpad that individually controls headrest and footrest allowing maximum comfort and support for your head, back and legs even for the tallest people. This model is available with two seat width options and it's modularity allows to make any size sofa or sectional.

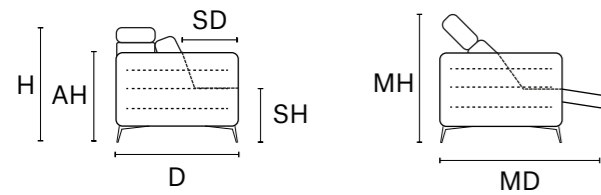

D 44" MD 71" H 35" AH 26" SH 19" SD 22" MH 41

MAXI SEAT (version of the group have the same seat width)

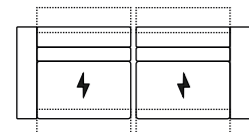

W 82"
V 106 + V108 SOFA MAXI RCL
ELETRIC HEAD-FOOT

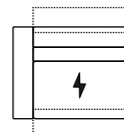

W 41"
V106 LHF ARMCHAIR MAXI RECLINER
HEAD AND FOOT
V121 LHF ARMCHAIR MAXI ONLY
ELETRIC HEADREST

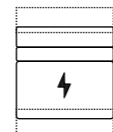

W 33"
V119 ARMLESS CHAIR MAXI RECLINER
ELETRIC HEAD AND FOOT
V120 ARMLESS CHAIR MAXI ONLY
ELETRIC HEADREST

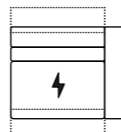

W 41"
V108 RHF ARMCHAIR MAXI RECLINER
HEAD AND FOOT
V122 RHF ARMCHAIR MAXI ONLY
ELETRIC HEADREST

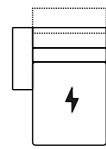

W 41"
D 69"
V 506 LHF CHAISE LOUNGE MAXI
ONLY ELETRIC HEADREST

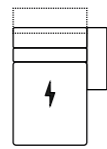

W 41"
D 69"
V 507 RHF CHAISE LOUNGE MAXI
ONLY ELETRIC HEADREST

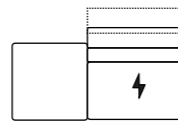

W 61"
V 166 LHF CHAIR MAXI MERIDIAN ONLY
ELETRIC HEADREST

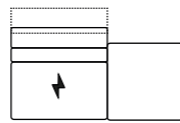

W 61"
V 167 RHF CHAIR MAXI MERIDIAN ONLY
ELETRIC HEADREST

MINI SEAT (version of the group have the same seat width)

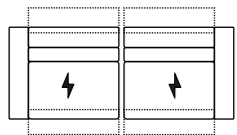

W 71"
V 125 + V 126 LOVESEAT MINI RCL
ELETRIC HEAD-FOOT

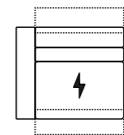

W 35"
V125 LHF ARMCHAIR MINI RECLINER
ELETRIC HEAD AND FOOT
V127 LHF ARMCHAIR MINI ONLY
ELETRIC HEADREST

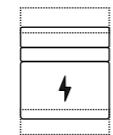

W 28"
V123 ARMLESS CHAIR MINI RECLINER
ELETRIC HEAD AND FOOT
V124 ARMLESS CHAIR MINI ONLY
ELETRIC HEADREST

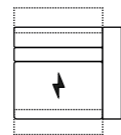

W 35"
V126 RHF ARMCHAIR MINI RECLINER
ELETRIC HEAD AND FOOT
V128 RHF ARMCHAIR MINI ONLY
ELETRIC HEADREST

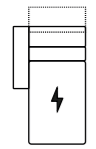

W 35"
D 69"
V 508 LHF CHAISE
LOUNGE MINI ONLY
ELETRIC HEADREST

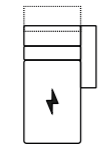

W 35"
D 69"
V 509 RHF CHAISE
LOUNGE MINI ONLY
ELETRIC HEADREST

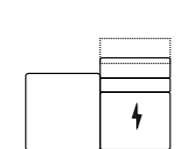

W 56"
V168 LHF CHAIR MINI MERIDIAN ONLY
ELETRIC HEADREST

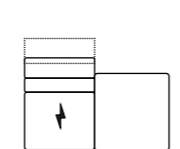

W 56"
V169 RHF CHAIR MINI MERIDIAN ONLY
ELETRIC HEADREST

JOLLY (can be combined with all the version group)

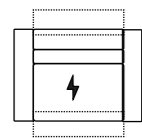

W 44"
V104 ARMCHAIR RECLINER
ELETRIC HEAD AND FOOT
V 150 ARMCHAIR
ONLY ELETRIC HEADREST

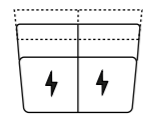

W 52"
MW 65"
V 251 LOVESEAT ARMLESS ANGLED
ONLY ELETRIC HEADREST

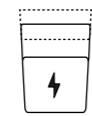

W 26"
MW 39"
V 160 ARMLESS CHAIR MAXI ANGLED
ONLY ELETRIC HEADREST

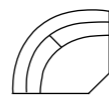

W 54"
D 54"
V 400 ROUND CORNER

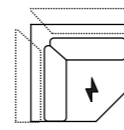

W 54"
D 54"
V 415 SQUARE CORNER
ELETRIC HEADREST

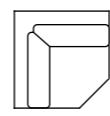

W 54"
D 54"
V 414 SQUARE CORNER

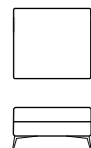

W 35"
D 30"
V600 OTTOMAN

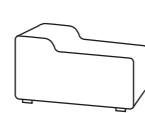

W 9"
H 22"
MH 26"
V613 CONSOLLE MINI STRAIGHT

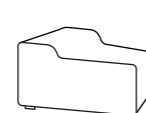

W 9"
MW 16"
H 22"
MH 26"
V614 CONSOLLE MINI ANGLE

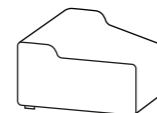

W 13"
MW 20"
H 22"
MH 26"
V620 CONSOLLE ANGLE

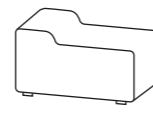

W 20"
H 22"
MH 26"
V621 CONSOLLE STRAIGHT

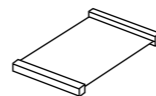

V701 TRAY CONSOLE



Foot Finishing Option



Foot Option 1:
Stainless Steel finish



Foot Option 2:
Stainless Steel Bronze Finish

Thin stitch standard



Thick stitch option



Decor Stich Option



Decor stitch:
Tipe A

Ermes

Technical Description

- decor stitch:** Tipe "A" as option
- thick stitch:** Available as option
- structure:** Hardwood frame for extra strength
- spring system:** Reinforced elastic webbing
- seat/back cushions:** High Density ecologic open-cell polyurethane foam covered with a layer of dacron wadding.
- removability:** Not available
- mechanisms:** Each seat has two separate motors, one for the headrest and one for the footrest
- battery pack:** Available as option
- usb:** Available as an option
- tray:** Wooden matt black finish, upon request on console
- base option # 1:** Stainless Steel finish
- base option # 2:** Stainless Steel Bronze Finish

LEATHER COLOR SHADE DIFFERENCES: The model upholstered with some Natural leather such as Maya, Moss, Carees and Sensation, could present in some area differences in color tones of about 5%. Such differences are not to be considered defect but an expression of the natural characteristic of the cowhide. The company reserves the right without prior notice to make technical sheets changes and/or materials for quality product improvement. Leather sofas are a handmade product and according to the leather covering selected there could be a measurement tolerance of about 2 inches (cm 5) on each sku.
REV. 002 DEL 28/10/2020 | Pag. 2 of 2



Focus

Here the armrests are embellished with a geometric design that starts from the feet and sinks into the softness of the sofa. Extreme comfort in just two movements to relax your head and feet.

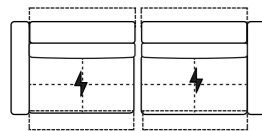

W 86"
V106 + V108 SOFA MAXI RCL ELECTRIC
HEAD-FOOT

Focus

Focus is a unique power motion designed to guarantee a sophisticated elegant look, comfort and relaxation. Focus is equipped with a state of the art power mechanism and touchpad that individually controls headrest and footrest allowing maximum comfort and support for your head, back and legs even for the tallest people. This model is available with two seat width options and it's modularity allows to make any size sofa or sectional. In addition, the seat and back is composed of memory foam and the extreme soft seating comfort perfectly adapts to the body. The armrest is very elegant and the sophisticated leg inserted in the outside arm gives this model a sartorial look.

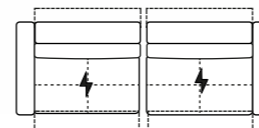

W 86"
V106 + V108 SOFA MAXI RCL ELECTRIC
HEAD-FOOT

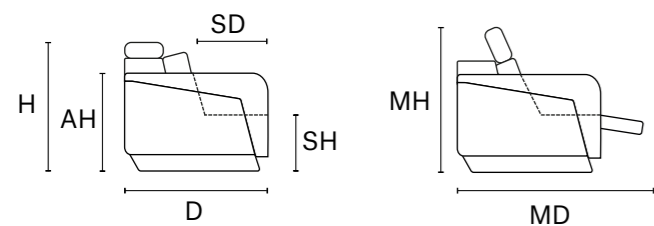

D 44" MD 67" H 33" AH 24" SH 19" SD 23" MH 41"

MAXI SEAT (version of the group have the same seat width)

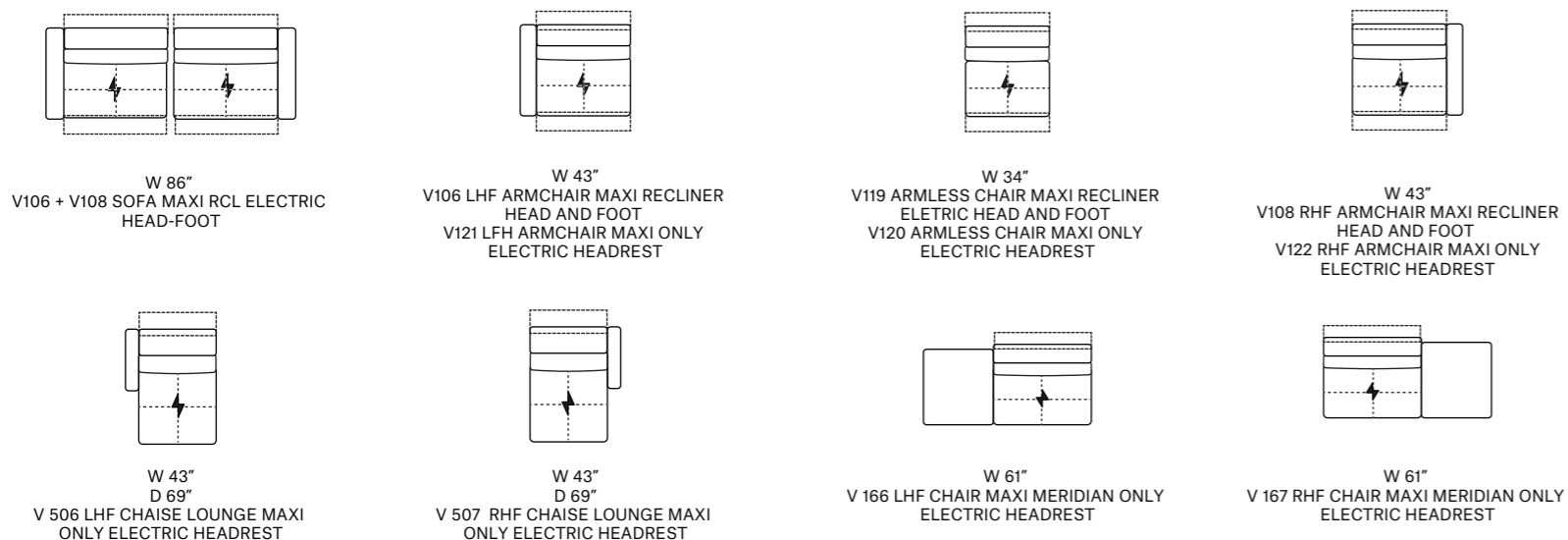

MINI SEAT (version of the group have the same seat width)

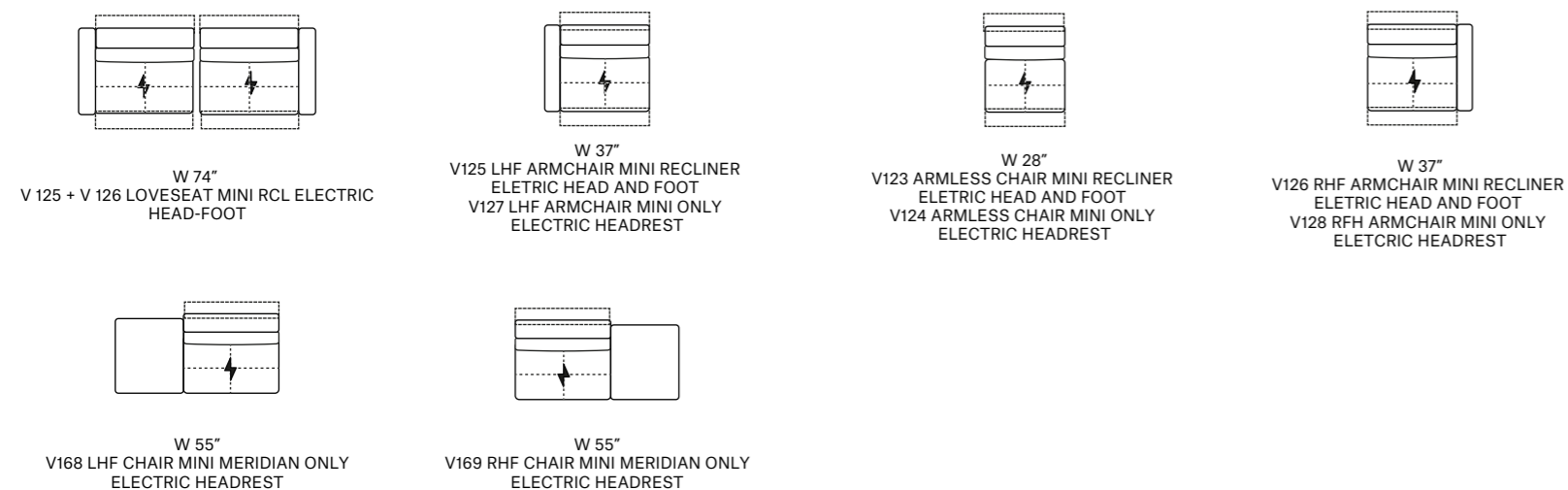

JOLLY (can be combined with all the version group)

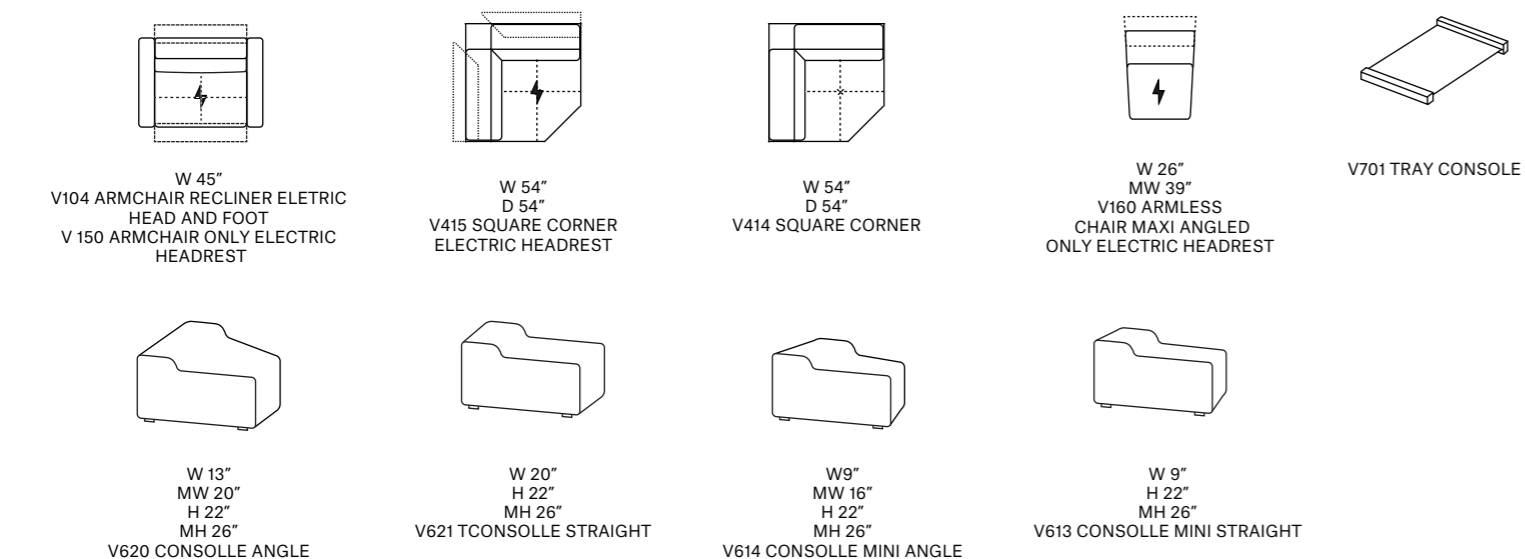

Foot Finishing Option



Foot Option 1:
Stainless Steel Arm Sled

Foot Option 2:
Stainless Steel Arm sled
Bronze Finish

Thin stitch standard



Thick stitch option



Focus

Technical Description

- thick stitch:** Available as option
- structure:** Hardwood frame for extra strenght
- seat/back suspension:** Reinforced elastic webbing
- seat/back cushions:** High density ecologic open-cell polyurethane foam with coil springs built inside the cushion covered with a layer of memory foam on top
- removability:** Not available
- mechanisms:** Each seat has two separate motors, one for the headrest and one for the footrest
- battery pack:** Available as option
- usb port:** Available as option
- cup holder:** Available as an option on skus V620 and V621
- foot option # 1 :** Stainless steel arm sled
- foot option # 2 :** Stainless steel arm sled bronze finish

LEATHER COLOR SHADE DIFFERENCES: The model upholstered with some Natural leather such as Maya, Moss, Carees and Sensation, could present in some area differences in color tones of about 5%. Such differences are not to be considered defect but an expression of the natural characteristic of the cowhide. The company reserves the right without prior notice to make technical sheets changes and/or materials for quality product improvement. Leather sofas are a handmade product and according to the leather covering selected there could be a measurement tolerance of about 2 inches (cm 5) on each sku.

Iride

Two separate mechanisms, one for head comfort and one for the legs. Fluid forms and enveloping lines that convey calm and balance, and immediate relaxation to your days.



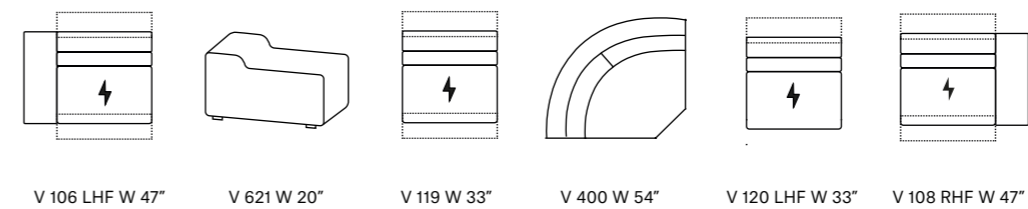
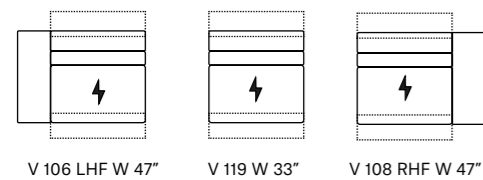

Iride

Iride is a power motion with a minimalist design which easily adapts to all living spaces. This model is equipped with a state of the art power mechanism and touchpad that individually controls headrest and footrest allowing maximum comfort and support for your head, back and legs even for the tallest people. This model is available with two seat width options and it's modularity allows to make any size sofa or sectional.

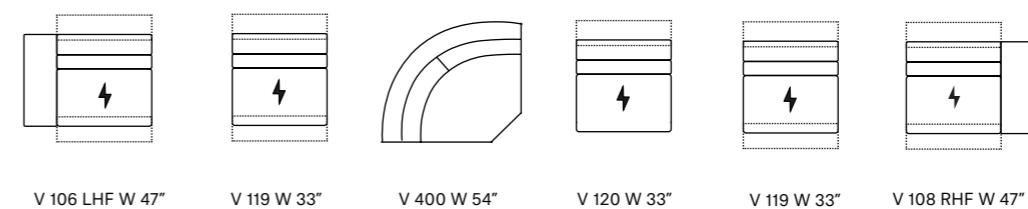
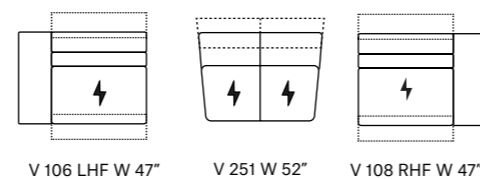

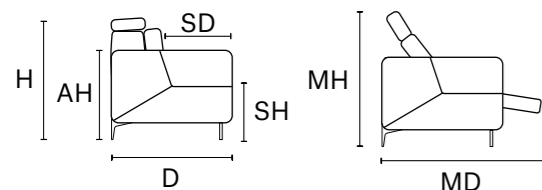

D 44" MD 71" H 34" AH 26" SH 19" SD 22" MH 41"

MAXI SEAT (version of the group have the same seat width)

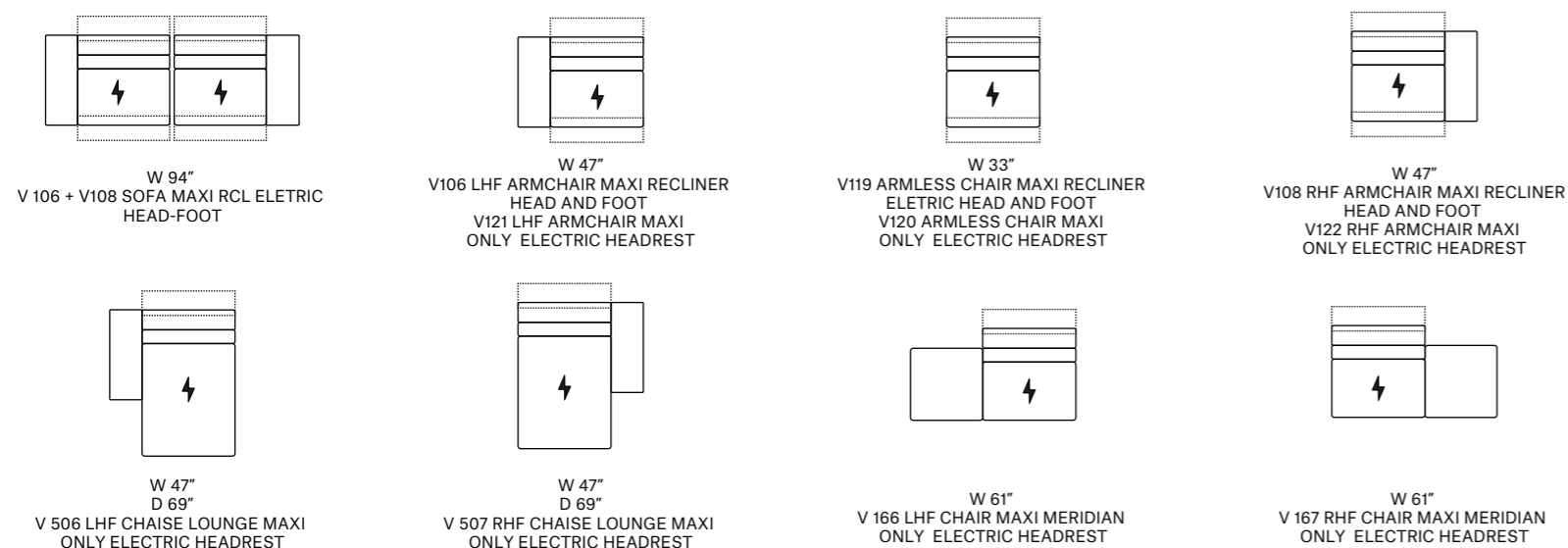

MINI SEAT (version of the group have the same seat width)

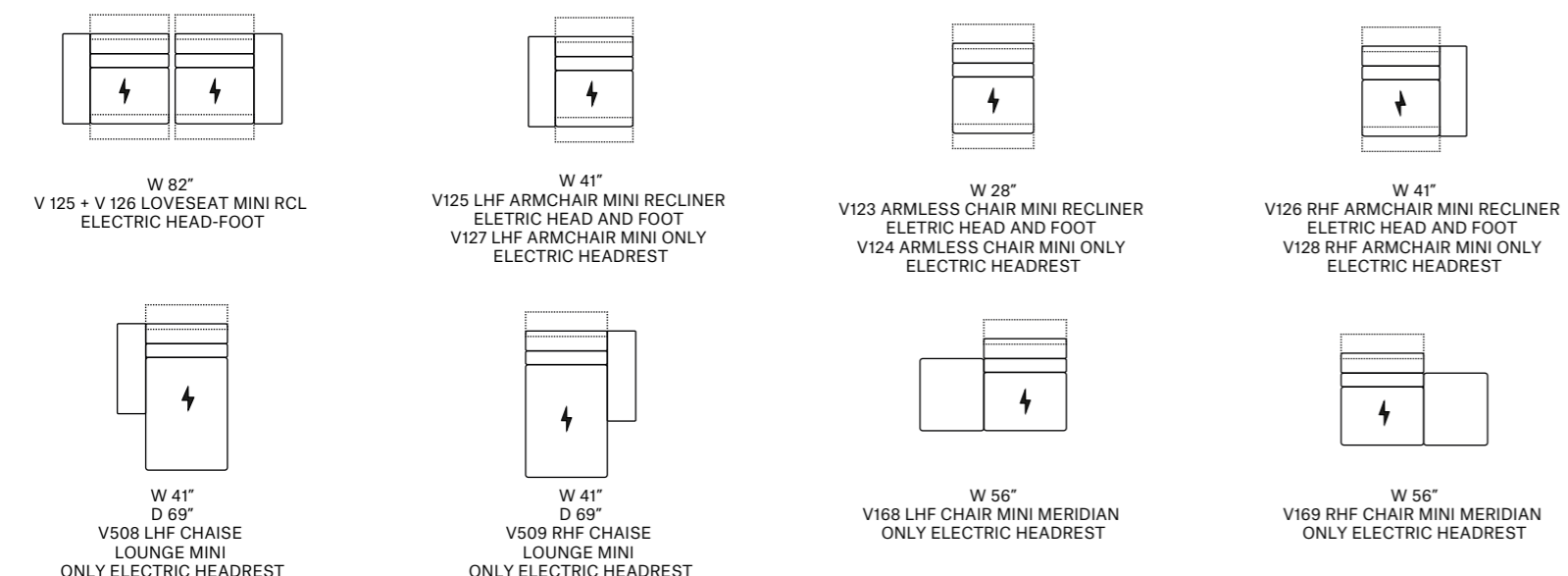

JOLLY (can be combined with all the version group)

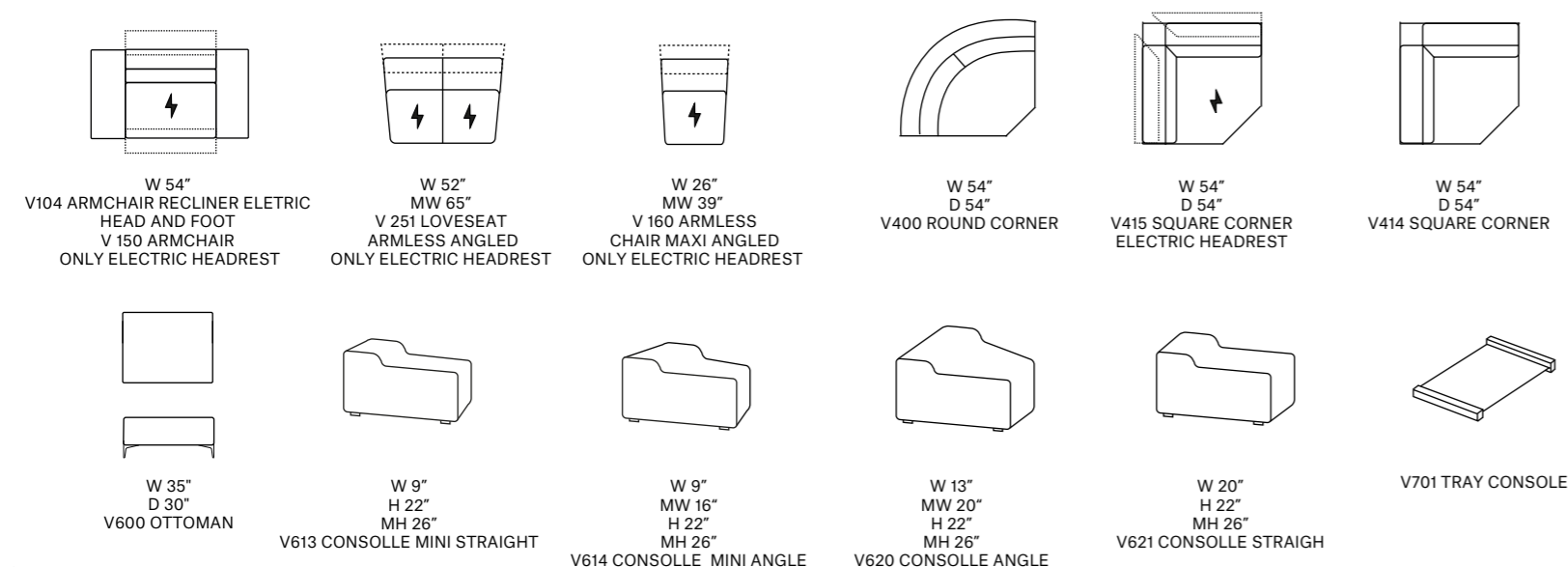

Foot Finishing Option



Foot Option 1:
Stainless Steel Finish

Foot Option 2:
Stainless Steel Bronze Finish

Thin stitch standard



Thick stitch option



Iride

Technical Description

- thick stitch:** Available as option
- structure:** Hardwood frame for extra strenght
- seat/back suspension :** Reinforced elastic webbing
- seat/back cushions:**High density Ecologic open-cell polyurethane foam covered with a layer of dacron wadding
- removability:** Not possible
- mechanisms:** Each seat has two separate motors, one for the headrest and one for the footrest
- battery pack:** Available as option
- tray:** Wooden matt black nishing, upon request on consolle
- foot option # 1:** Stainless steel finish
- foot option # 2:** Metal feet bronze finish
- usb:** Available as option

LEATHER COLOR SHADE DIFFERENCES: The model upholstered with some Natural leather such as Maya, Moss, Carees and Sensation, could present in some area differences in color tones of about 5%. Such differences are not to be considered defect but an expression of the natural characteristic of the cowhide. The company reserves the right without prior notice to make technical sheets changes and/or materials for quality product improvement. Leather sofas are a handmade product and according to the leather covering selected there could be a measurement tolerance of about 2 inches (cm 5) on each sku.
REV. 002 DEL 28/10/2020 | Pag. 2 of 2

Jerry

The arms and backrest become a real alcove. The comfort here is total, thanks to the power motion technology which follows the body's movement. Then to the comfort, you add quality and design, which allows to discover new furniture solutions tailored to everybody's own idea of the Living Area.



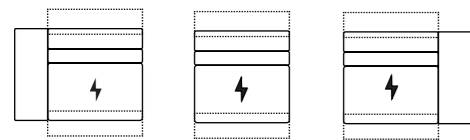

V 106 LHF W 44" V 119 W 34" V 108 RHF W 44"

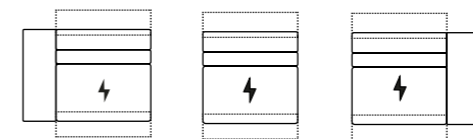

V 106 LHF W 44" V 119 W 34" V 108 RHF W 44"

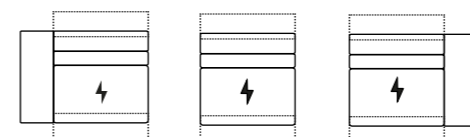

V 106 LHF W 44" V 119 W 34" V 108 RHF W 44"

Jerry

Jerry is a unique power motion designed to guarantee a sophisticated elegant look, comfort and relaxation. Jerry is equipped with a state of the art power mechanism and touchpad that individually controls headrest and footrest allowing maximum comfort and support for your head, back and legs even for the tallest people. This model is available with two seat width options and it's modularity allows to make any size sofa or sectional. In addition, the seat and back is composed of memory foam and the extreme soft seating comfort perfectly adapts to the body.

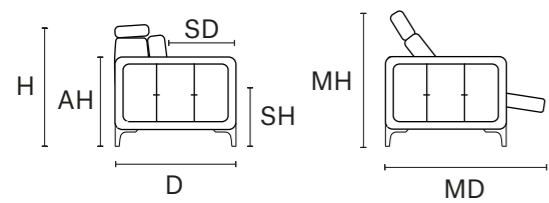

D 44" MD 67" H 33" AH 24" SH 19" SD 23" MH 41"

MAXI SEAT (version of the group have the same seat width)

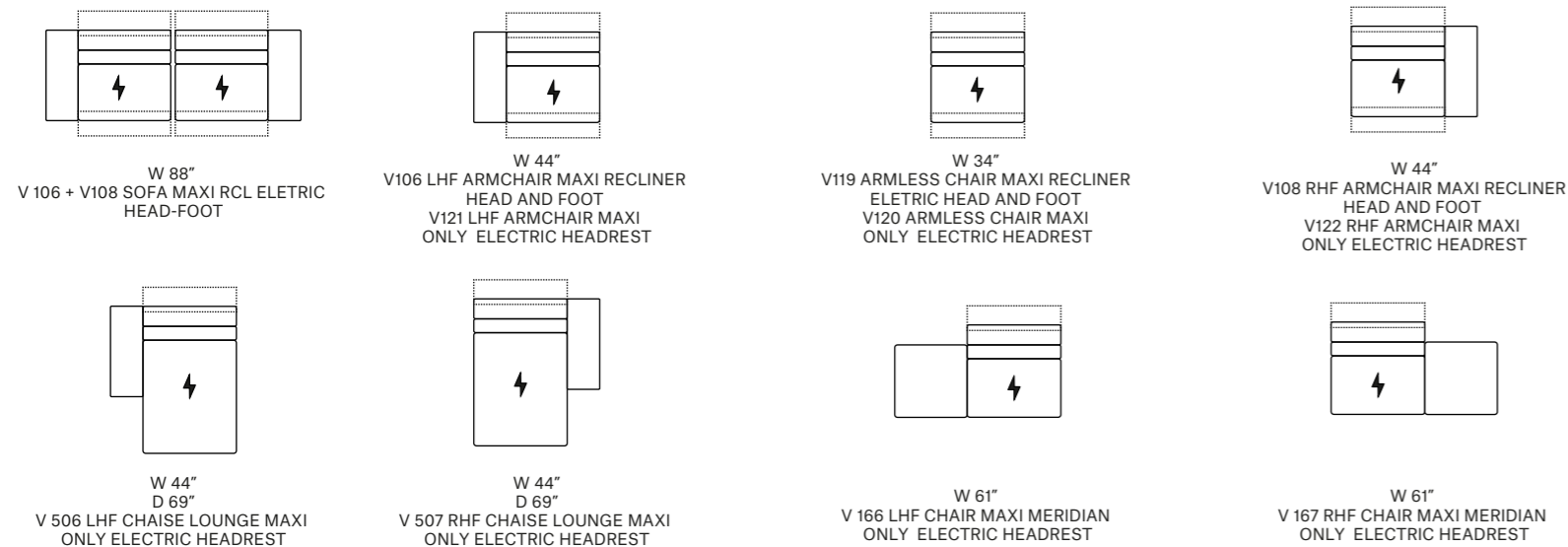

MINI (version of the group have the same seat width)

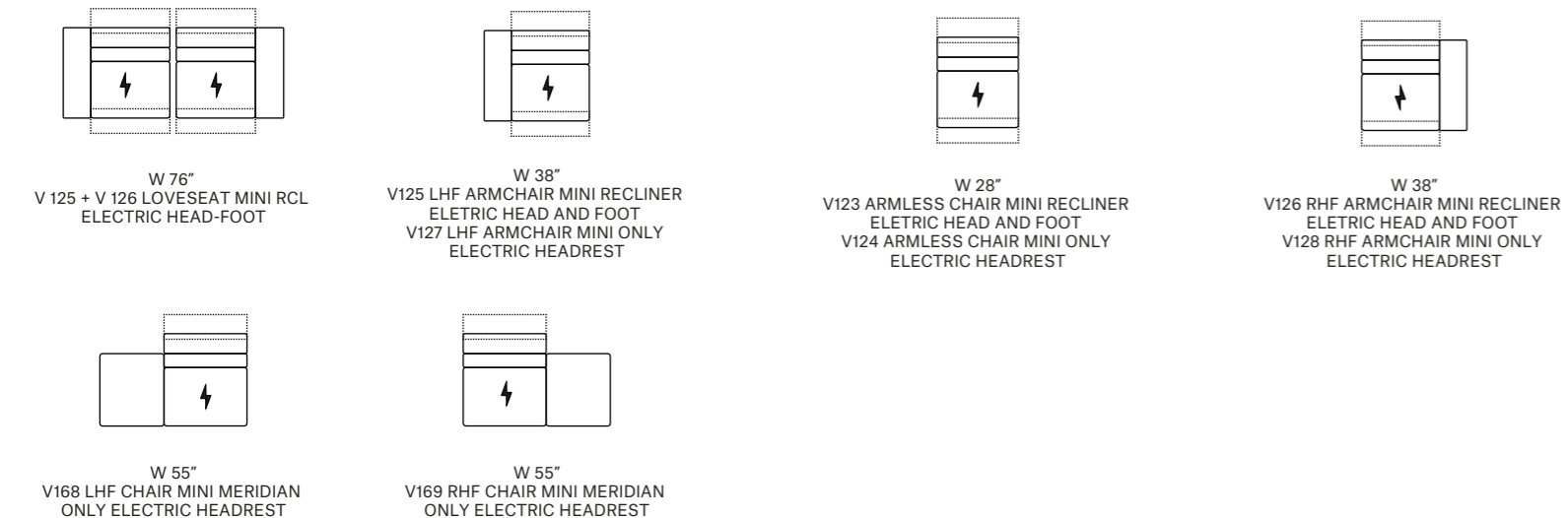

JOLLY (can be combined with all the version group)

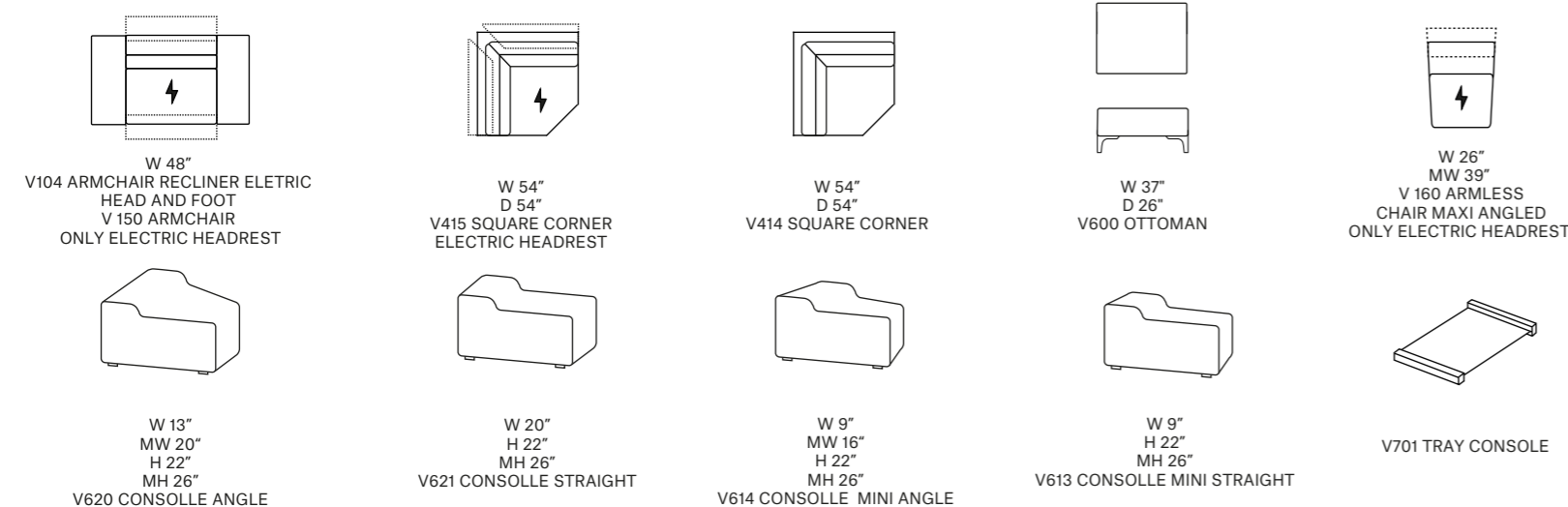

Foot Finishing Option



Foot Option 1:
Stainless Steel Finish



Foot Option 2:
Stainless Steel Bronze Finishing

Thin stitch standard



Thick stitch option



Decor Stich Option



Decor stitch:
Tipe I

Jerry

Technical Description

- decor stitch:** Tipe "I" Available as option
- thick stitch:** Available as option
- structure:** Hardwood frame for extra strenght
- spring system:** Reinforced Elastic webbing
- seat/back suspension :** Hight density ecologic open-cell polyurethane foam with coll springs built inside the cushion, covered with a layer of memory foam on top
- removability:** Not possible
- mechanisms:** Each seat has two separate motors, one for the headrest and one for the footrest
- usb:** Available as option
- battery pack:** Available as option
- foot option # 1:** Stainless Steel Finish
- foot option # 2:** Stainless Steel Bronze Finishing

LEATHER COLOR SHADE DIFFERENCES: The model upholstered with some Natural leather such as Maya, Moss, Carees and Sensation, could present in some area differences in color tones of about 5%. Such differences are not to be considered defect but an expression of the natural characteristic of the cowhide. The company reserves the right without prior notice to make technical sheets changes and/or materials for quality product improvement. Leather sofas are a handmade product and according to the leather covering selected there could be a measurement tolerance of about 2 inches (cm 5) on each sku.



Kaos

Touch firsthand the work of the craftsmen, sliding your fingers along the visible stitching, activating the recliner feature with a simple touch. Kaos is a sofa synonymous with Bracci's leather processing excellence.

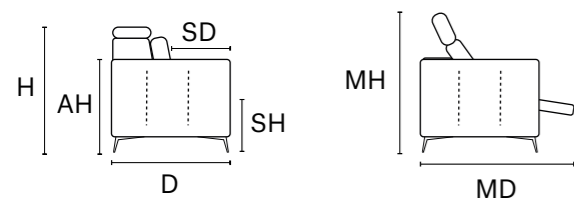

D 44" MD 71" H 35" AH 26" SH 19" SD 22" MH 41"

MAXI SEAT (version of the group have the same seat width)

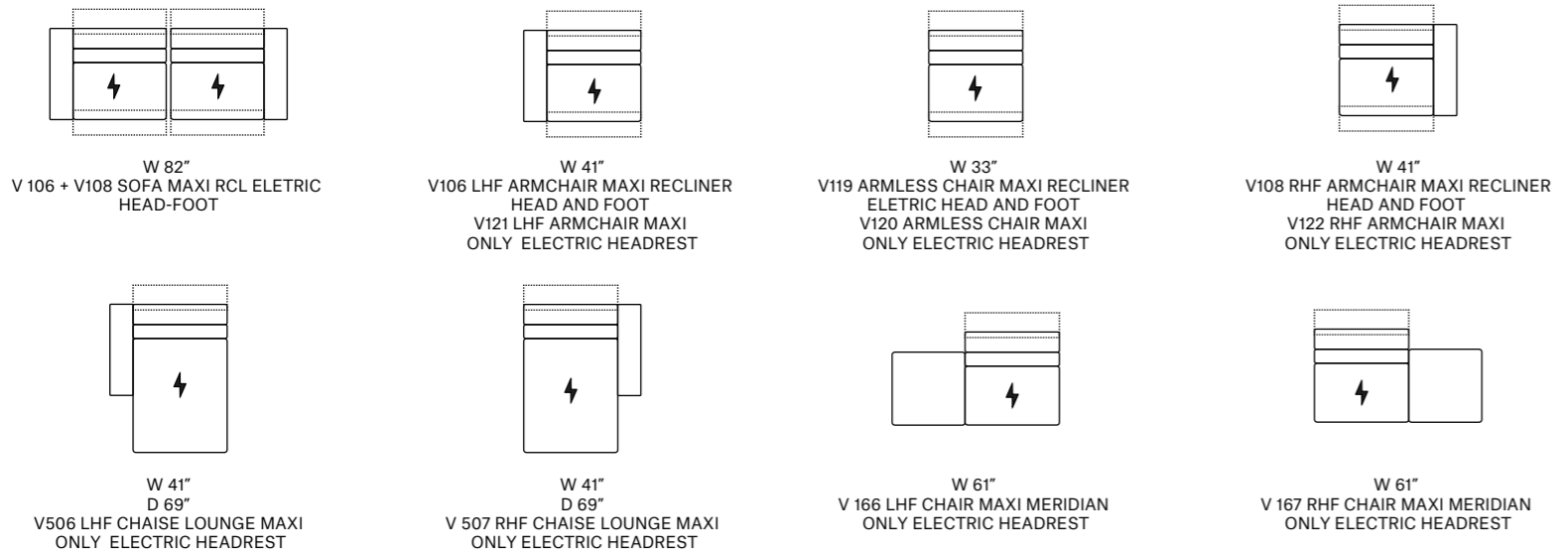

MINI SEAT (version of the group have the same seat width)

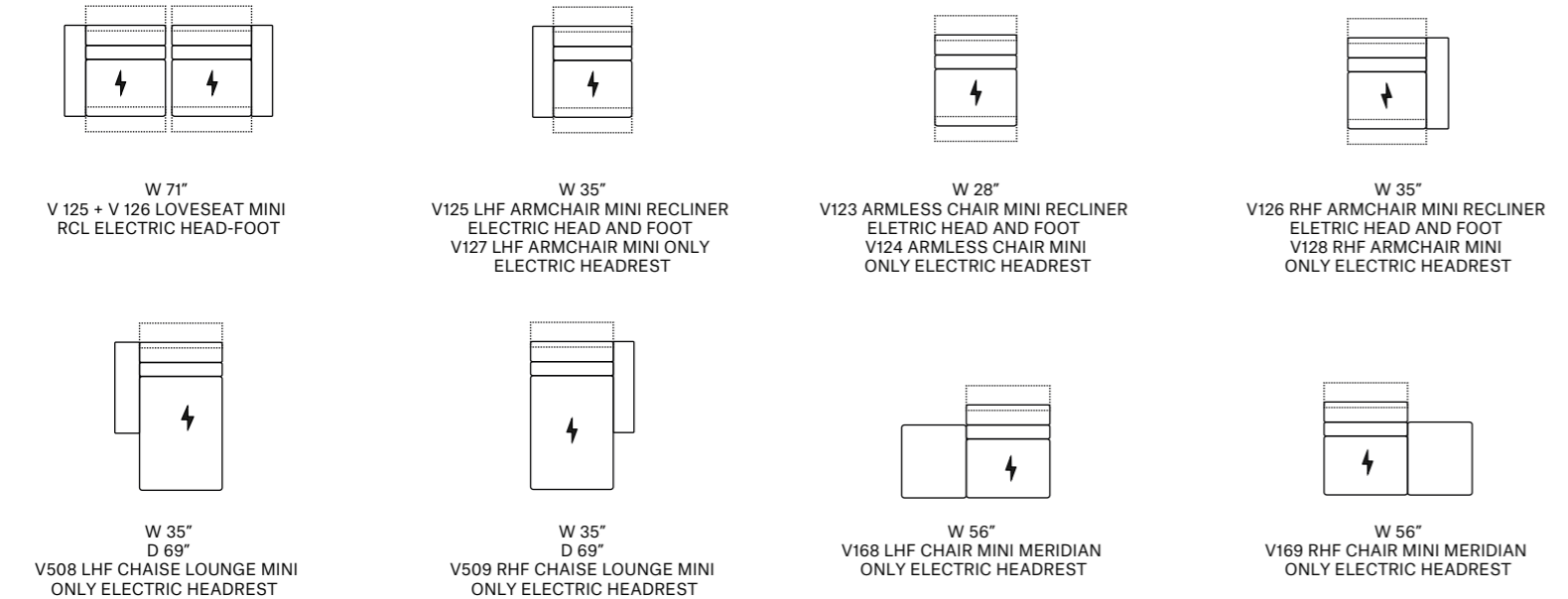

JOLLY (can be combined with all the version group)

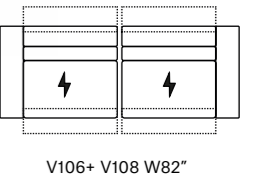
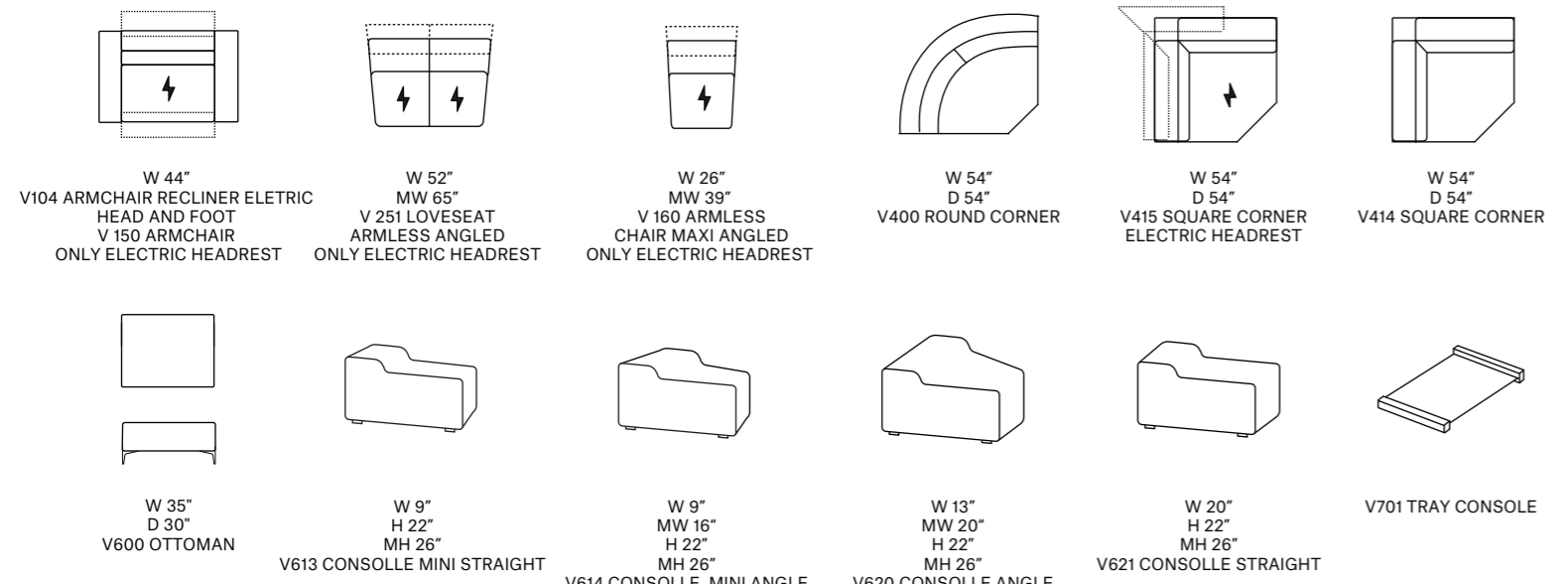

Kaos

Kaos is a power motion with a sophisticated thin arm that easily adapts to all living spaces. Kaos is equipped with a state of the art power mechanism and touchpad that individually controls headrest and footrest allowing maximum comfort and support for your head, back and legs even for the tallest people. This model is available with two seat width options and it's modularity allows to make any size sofa or sectional.

Foot Finishing Option



Foot Option 1:
Stainless Steel finish



Foot Option 2:
Stainless Steel Bronze Finish

Technical Description

- decor stitch "A":** Available as option
- thick stitch:** Available as option
- structure:** Hardwood frame for extra strenght
- seat/back suspension:** Reinforced elastic webbing
- seat/back cushions:** High density Ecologic open-cell polyurethane foam covered with a layer of dacron wadding
- removability:** Not possible
- mechanisms:** Each seat has two separate motors, one for the headrest and one for the footrest
- battery pack:** Available as option
- tray:** Wooden matt black finishing, upon request on console
- foot option # 1 :** Stainless steel finish
- foot option # 2 :** Stainless Steel Bronze Finish
- usb:** Available as option

Thin stitch standard



Thick stitch option



Decor stitch option



Decor Stitch:
Tipe A

Lory

Lory is a big and welcoming embrace. The seats are comfortable, very comfortable thanks to the internal mechanism that relaxes the head and feet. You can recharge your phone, safely rest your drink, and finally let yourself go.



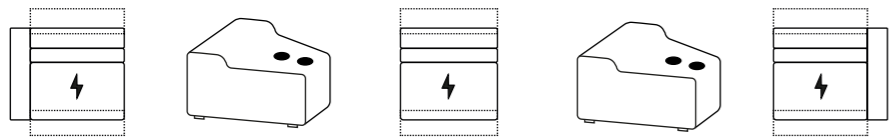

V106 LHF W43" V614 W9"+ cup holders V119 W34" V614 W9"+ cup holders V108 RHF W43"

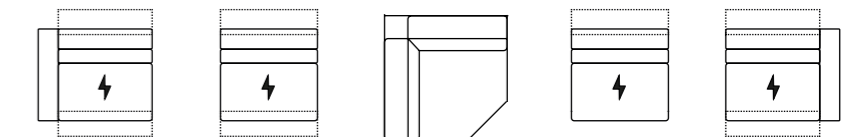

V106 LHF W43" V119 W34" V414 W50" V120 W34" V108 RHF W43"



Lory

Lory is a unique power motion with a sophisticated minimal elegant look. Lory is equipped with a state of the art power mechanism and touchpad that individually controls headrest and footrest allowing maximum comfort and support for your head, back and legs even for the tallest people. This model is available with two seat width options and it's modularity allows to make any size sofa or sectional. In addition, the seat and back is of memory foam and the extreme soft seating comfort perfectly adapts to the body.

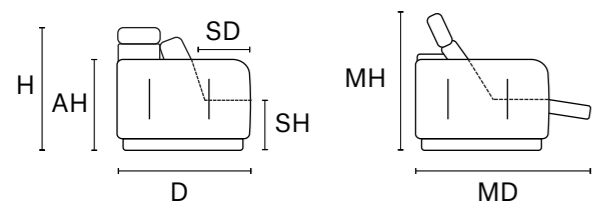

D 44" MD 67" H 33" AH 26" SH 19" SD 23" MH 41"

MAXI SEAT (version of the group have the same seat width)

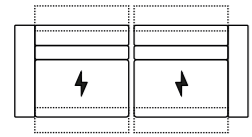

W 86"
V106+V108 SOFA MAXI RCL
ELECTRIC HEAD- FOOT

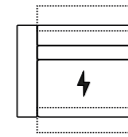

W 43"
V106 LHF ARMCHAIR MAXI RECLINER
HEAD AND FOOT
V 121 LHF ARMCHAIR MAXI
ONLY ELECTRIC HEADREST

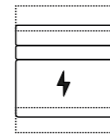

W 34"
V119 ARMLESS CHAIR MAXI RECLINER
ELECTRIC HEAD AND FOOT
V120 ARMLESS CHAIR MAXI
ONLY ELECTRIC HEADREST

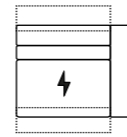

W 43"
V108 RHF ARMCHAIR MAXI RECLINER
HEAD AND FOOT
V 122 RHF ARMCHAIR MAXI
ONLY ELECTRIC HEADREST

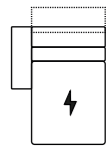

W 43"
D 69"
V506 LHF CHAISE LONGUE MAXI
ONLY ELECTRIC HEADREST

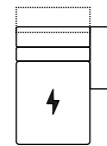

W 43"
D 69"
V507 RHF CHAISE LONGUE MAXI
ONLY ELECTRIC HEADREST

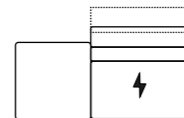

W 61"
V166 LHF CHAIR MAXI MERIDIAN
ONLY ELECTRIC HEADREST

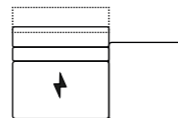

W 61"
V167 RHF CHAIR MAXI MERIDIAN
ONLY ELECTRIC HEADREST



MINI SEAT (version of the group have the same seat width)

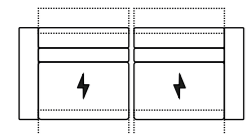

W 74"
V125+V126 LOVE SEAT MINI
RCL ELECTRIC HEAD-FOOT

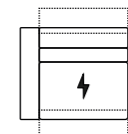

W 37"
V125 LHF ARMCHAIR MINI RECLINER
ELECTRIC HEAD AND FOOT
V 127 LHF ARMCHAIR MAXI
ONLY ELECTRIC HEADREST

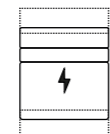

W 28"
V123 ARMLESS CHAIR MAXI RECLINER
ELECTRIC HEAD AND FOOT
V124 ARMLESS CHAIR MINI
ONLY ELECTRIC HEADREST

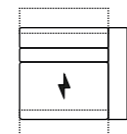

W 37"
V126 RHF ARMCHAIR MINI RECLINER
ELECTRIC HEAD AND FOOT
V 128 RHF ARMCHAIR MINI ONLY
ELECTRIC HEADREST

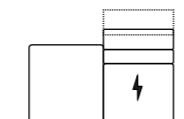

W 55"
V168 LHF CHAIR MINI MERIDIAN
ONLY ELECTRIC HEADREST

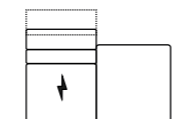

W 55"
V169 RHF CHAIR MINI MERIDIAN
ONLY ELECTRIC HEADREST

JOLLY (can be combined with all the version group)

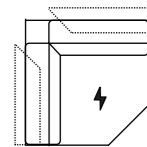

W 54"
D 54"
V415 SQUARE CORNER
ELECTRIC HEADREST

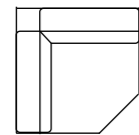

W 54"
D 54"
V414 SQUARE CORNER

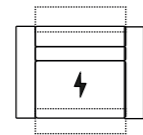

W 46"
V104 ARMCHAIR RECLINER
ELECTRIC HEAD AND FOOT
V150 ARMCHAIR
ONLY ELECTRIC HEADREST

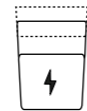

W 26"
MW 39"
V160 ARMLESS CHAIR MAXI ANGLED
ONLY ELECTRIC HEADREST

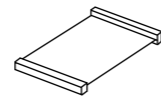

V701 TRAY CONSOLE



W 20"
H 22"
MH 26"
V621 CONSOLLE STRAIGHT

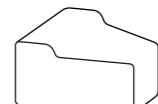

W 13"
MW 20"
H 22"
MH 26"
V620 CONSOLLE ANGLE

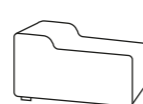

W 9"
H 22"
MH 26"
V613 CONSOLLE MINI STRAIGHT



W 9"
MW 16"
H 22"
MH 26"
V614 CONSOLLE MINI ANGLE

Foot Finishing Option

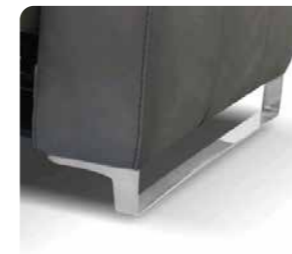

Foot Option 1:
Stainless Steel Sled



Foot Option 2:
Stainless Steel Sled Bronze Finish

Thin stitch standard



Thick stitch option



Lory

Technical Description

thick stitch: Available as option

structure: Hardwood frame for extra strenght

seat/back suspension : Reinforced elastic webbing

seat/back cushions: High density ecologic open cell polyurethane foam with coil springs built inside the cushion with a layer of memory foam on top

removability: not available

mechanisms: Each seat has two separate motors, one for the headrest and one for the footrest

battery pack: Available as option

usb port: Available as option

foot option # 1: Stainless steel sled

foot option # 2: Stainless steel sled bronze finish

LEATHER COLOR SHADE DIFFERENCES: The model upholstered with some Natural leather such as Maya, Moss, Carees and Sensation, could present in some area differences in color tones of about 5%. Such differences are not to be considered defect but an expression of the natural characteristic of the cowhide. The company reserves the right without prior notice to make technical sheets changes and/or materials for quality product improvement. Leather sofas are a handmade product and according to the leather covering selected there could be a measurement tolerance of about 2 inches (cm 5) on each sku.

Lucy

Model Lucy has a light and soft design in movement. Lucy furnishes the Living area with very comfortable cushions made in high density polyurethane foam, and with an internal technology which allows to stretch the body according to the desired comfort.



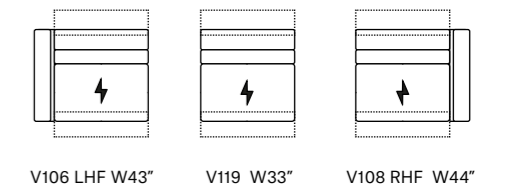
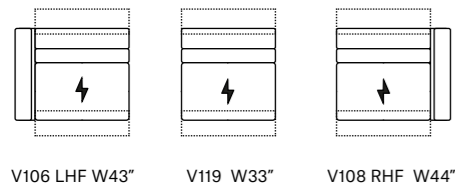

Lucy

Lucy is a power motion with a minimalist design which easily adapts to all living spaces. Lucy is equipped with a state of the art power mechanism and touchpad that individually controls headrest and footrest allowing maximum comfort and support for your head, back and legs even for the tallest people. This model is available with two seat width options and it's modularity allows to make any size sofa or sectional.

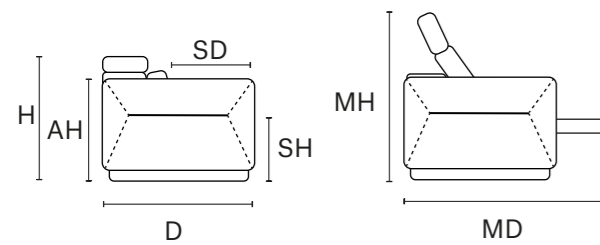

D 44" MD 71" H 35" AH 26" SH 19" SD 22" MH 41"

MAXI SEAT (version of the group have the same seat width)

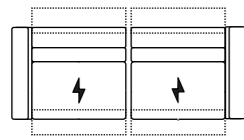

W 82"
V106+V108 SOFA MAXI RCL
ELECTRIC HEAD- FOOT

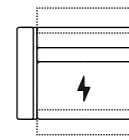

W 41"
V106 LHF ARMCHAIR MAXI RECLINER
HEAD AND FOOT
V 121 LHF ARMCHAIR MAXI
ONLY ELECTRIC HEADREST

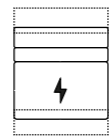

W 33"
V119 ARMLESS CHAIR MAXI
RECLINER ELECTRIC HEAD AND FOOT
V120 ARMLESS CHAIR MAXI
ONLY ELECTRIC HEADREST

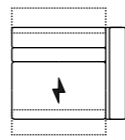

W 41"
V108 RHF ARMCHAIR MAXI RECLINER
HEAD AND FOOT
V 122 RHF ARMCHAIR MAXI
ONLY ELECTRIC HEADREST

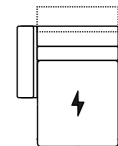

W 41"
D 69"
V506 LHF CHAISE LONGUE MAXI
ONLY ELECTRIC HEADREST

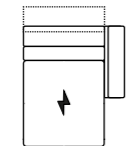

W 41"
D 69"
V507 RHF CHAISE LONGUE MAXI
ONLY ELECTRIC HEADREST

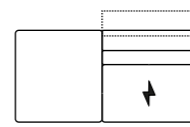

W 61"
V166 LHF CHAIR MAXI MERIDIAN
ONLY ELECTRIC HEADREST

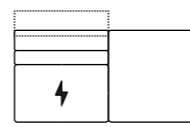

W 61"
V167 RHF CHAIR MAXI MERIDIAN
ONLY ELECTRIC HEADREST

MINI SEAT (version of the group have the same seat width)

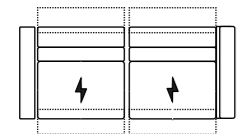

W 69"
V125+V126 LOVE SEAT MINI
RCL ELECTRIC HEAD-FOOT

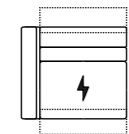

W 34"
V125 LHF ARMCHAIR MINI RECLINER
ELECTRIC HEAD AND FOOT
V 127 LHF ARMCHAIR MINI
ONLY ELECTRIC HEADREST

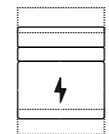

W 28"
V123 ARMLESS CHAIR MINI
RECLIER ELECTRIC HEAD AND FOOT
V124 ARMLESS CHAIR MINI
ONLY ELECTRIC HEADREST

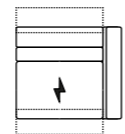

W 34"
V126 RHF ARMCHAIR MINI RECLINER
ELECTRIC HEAD AND FOOT
V 128 RHF ARMCHAIR MINI
ONLY ELECTRIC HEADREST

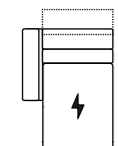

W 34"
D 69"
V508 LHF CHAISE LONGUE MINI
ONLY ELECTRIC HEADREST

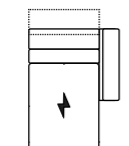

W 34"
D 69"
V509 RHF CHAISE LONGUE MINI
ONLY ELECTRIC HEADREST

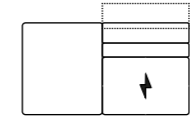

W 56"
V168 LHF CHAIR MINI MERIDIAN
ONLY ELECTRIC HEADREST

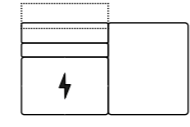

W 56"
V169 RHF CHAIR MINI MERIDIAN
ONLY ELECTRIC HEADREST

JOLLY (can be combined with all the version group)

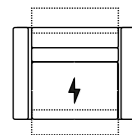

W 41"
V104 ARMCHAIR RECLINER
ELECTRIC HEAD AND FOOT
V150 ARMCHAIR
ONLY ELECTRIC HEADREST

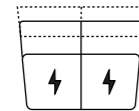

W 52"
MW 65"
V 251 LOVESEAT
ARMLESS ANGLED
ONLY ELECTRIC HEADREST

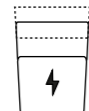

W 26"
MW 39"
V160 ARMLESS CHAIR MAXI ANGLED
ONLY ELECTRIC HEADREST



W 54"
D 54"
V400 ROUND CORNER

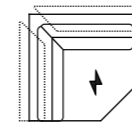

W 54"
D 54"
V415 SQUARE CORNER
ELECTRIC HEADRST

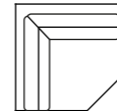

W 54"
D 54"
V414 SQUARE CORNER

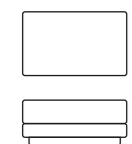

W 35"
D 30"
V600 OTTOMAN

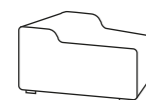

W 9"
MW 16"
H 22"
MH 26"

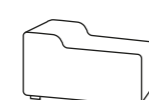

W 9"
H 22"
MH 26"
V613 CONSOLLE MINI STRAIGHT

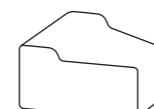

W 13"
MW 20"
H 22"
MH 26"

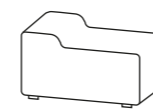

W 20"
H 22"
MH 26"
V621 CONSOLLE STRAIGHT

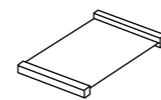

V701 TRAY CONSOLE



Foot Finishing Option



Foot Option 1:
Stainless Steel Finish Sled



Foot Option 2:
Stainless Steel Bronze Finish Sled

Thin stitch standard



Lucy

Technical Description

- thick stitch:** Not available
- structure:** Hardwood frame for extra strenght
- spring system :** Reinforced elastic webbing
- seat/back cushions:** High density open-cell Ecologic polyurethane foam covered with a layer of dacron wadding
- mechanisms:** Each seat has two separate motors, one for the headrest and one for the footrest
- battery pack:** Available as option
- usb port:** Available as option
- tray:** Wooden matt finishing, upon request on console
- foot option # 1:** Stainless Steel Finish Sled
- foot option # 2:** Stainless Steel Bronze Finish Sled

LEATHER COLOR SHADE DIFFERENCES: The model upholstered with some Natural leather such as Maya, Moss, Carees and Sensation, could present in some area differences in color tones of about 5%. Such differences are not to be considered defect but an expression of the natural characteristic of the cowhide. The company reserves the right without prior notice to make technical sheets changes and/or materials for quality product improvement. Leather sofas are a handmade product and according to the leather covering selected there could be a measurement tolerance of about 2 inches (cm 5) on each sku.
REV. 002 DEL 28/10/2020 | Pag. 2 of 2

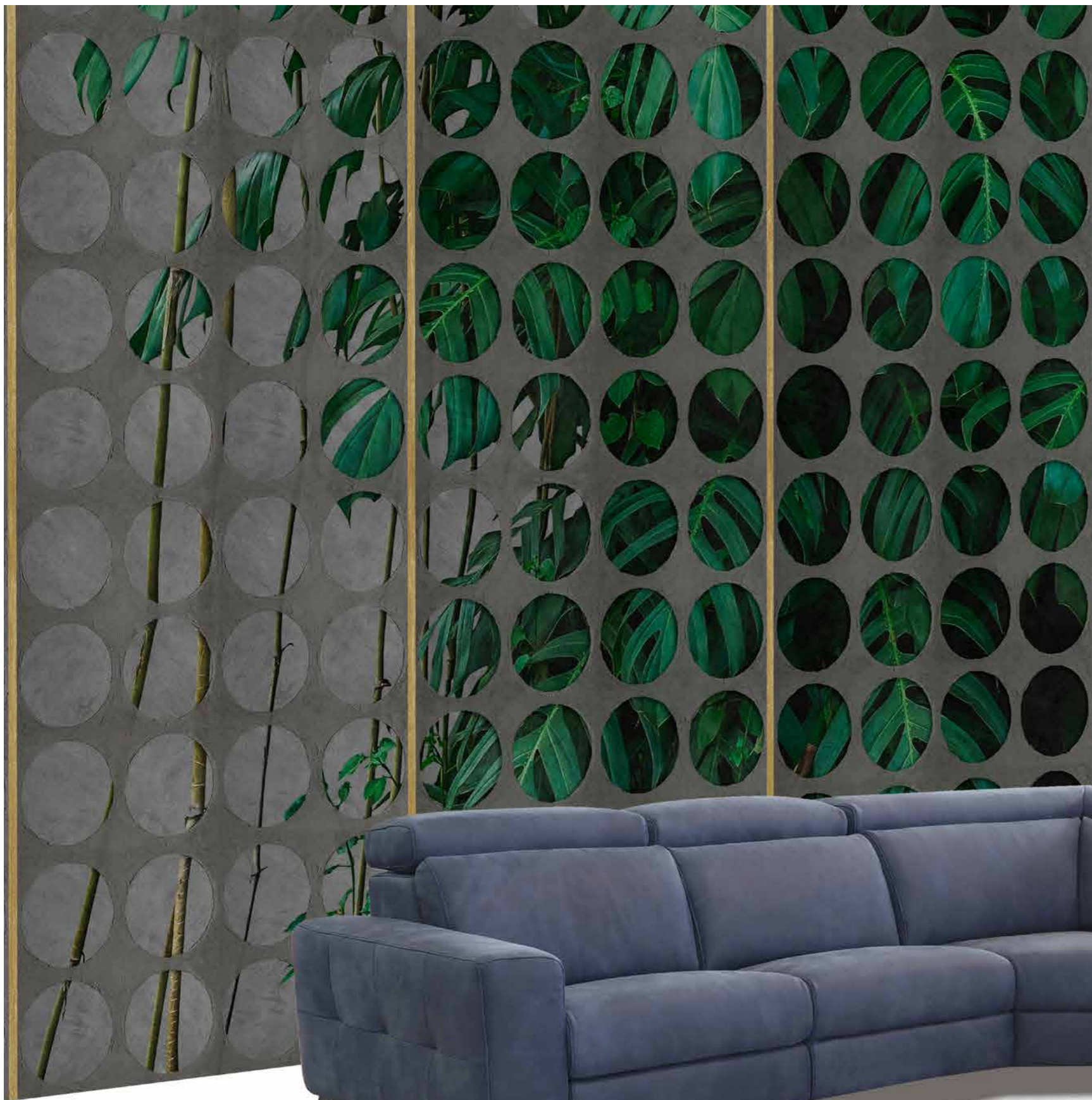

Medusa

Its characteristic quilting and unmistakable design speak of welcoming in true Italian style. This is how Medusa furnishes the living area with the innovative comfort of the most advanced recliner features.



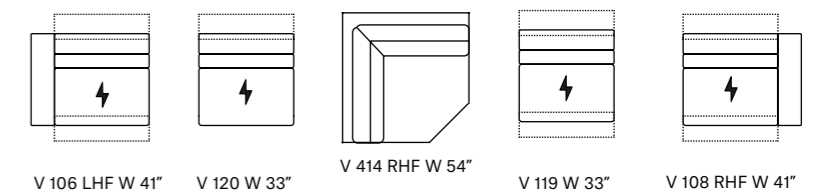
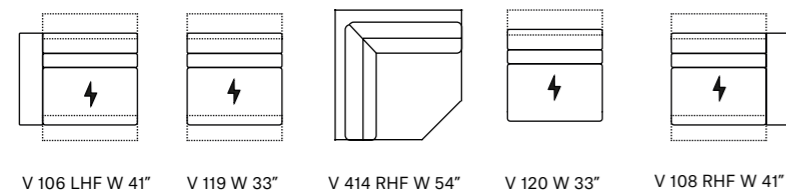

Medusa

Medusa is a power motion with an elegant modern look which easily adapts to all living spaces. Medusa is equipped with a state of the art power mechanism and touchpad that individually controls headrest and footrest allowing maximum comfort and support for your head, back and legs. This model is available with two seat width options and it's modularity allows to make any size sofa or sectional.

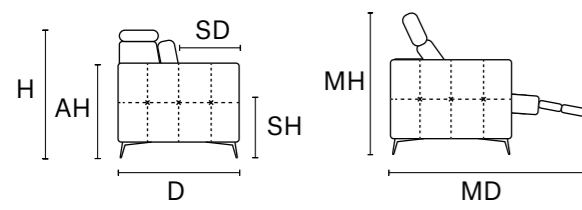

D 44" MD 71" H 35" AH 26" SH 19" SD 22" MH 41"

MAXI SEAT (version of the group have the same seat width)

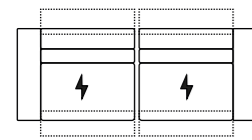

W 82"
V 106 + V108 SOFA MAXI RCL
ELECTRIC HEAD-FOOT

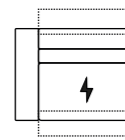

W 41"
V106 LHF ARMCHAIR MAXI RECLINER
HEAD AND FOOT
V121 LHF ARMCHAIR MAXI
ONLY ELECTRIC HEADREST

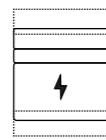

W 33"
V119 ARMLESS CHAIR MAXI RECLINER
ELECTRIC HEAD AND FOOT
V120 ARMLESS CHAIR MAXI
ONLY ELECTRIC HEADREST

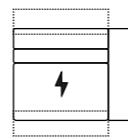

W 41"
V108 RHF ARMCHAIR MAXI RECLINER
HEAD AND FOOT
V122 RHF ARMCHAIR MAXI
ONLY ELECTRIC HEADREST

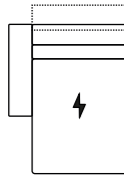

W 41"
D 69"
V 506 LHF CHAISE LOUNGE MAXI
ONLY ELECTRIC HEADREST

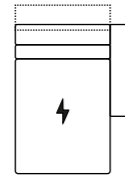

W 41"
D 69"
V 507 RHF CHAISE LOUNGE MAXI
ONLY ELECTRIC HEADREST

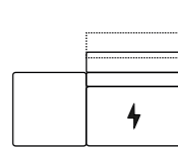

W 61"
V 166 LHF CHAIR MAXI MERIDIAN
ONLY ELECTRIC HEADREST

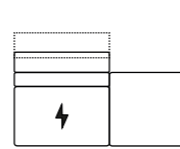

W 61"
V 167 RHF CHAIR MAXI MERIDIAN
ONLY ELECTRIC HEADREST

MINI SEAT (version of the group have the same seat width)

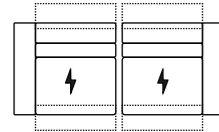

W 71"
V 125 + V 126 LOVESEAT MINI RCL
ELECTRIC HEAD-FOOT

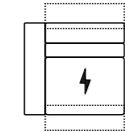

W 35"
V125 LHF ARMCHAIR MINI RECLINER
ELECTRIC HEAD AND FOOT
V127 LHF ARMCHAIR MINI
ONLY ELECTRIC HEADREST

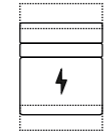

W 28"
V123 ARMLESS CHAIR MINI RECLINER
ELECTRIC HEAD AND FOOT
V124 ARMLESS CHAIR MINI
ONLY ELECTRIC HEADREST

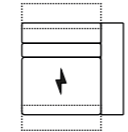

W 35"
V126 RHF ARMCHAIR MINI RECLINER
ELECTRIC HEAD AND FOOT
V128 RHF ARMCHAIR MINI
ONLY ELECTRIC HEADREST

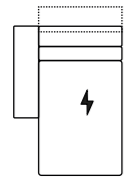

W 35"
D 69"
V 508 LHF
CHAISE LOUNGE MINI
ONLY ELECTRIC HEADREST

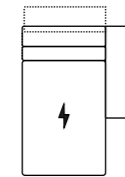

W 35"
D 69"
V 509 RHF
CHAISE LOUNGE MINI
ONLY ELECTRIC HEADREST

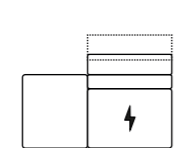

W 56"
V168 LHF CHAIR MINI MERIDIAN
ONLY ELECTRIC HEADREST

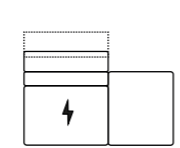

W 56"
V169 RHF CHAIR MINI MERIDIAN
ONLY ELECTRIC HEADREST

JOLLY (can be combined with all the version group)

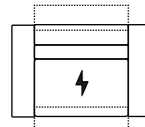

W 44"
V104 ARMCHAIR RECLINER
ELECTRIC HEAD AND FOOT
V 150 ARMCHAIR
ONLY ELECTRIC HEADREST

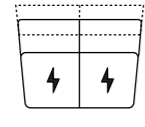

W 52"
MW 65"
V 251 LOVESEAT
ARMLESS ANGLED
ONLY ELECTRIC HEADREST

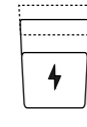

W 26"
MW 39"
V 160 ARMLESS CHAIR
MAXI ANGLED
ONLY ELECTRIC HEADREST

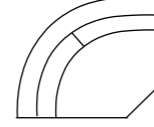

W 54"
D 54"
V 400 ROUND CORNER

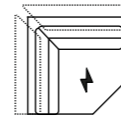

W 54"
D 54"
V 415 SQUARE CORNER
ELECTRIC HEADREST

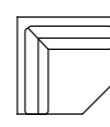

W 54"
D 54"
V 414 SQUARE CORNER

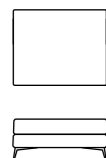

W 35"
D 30"
V600 OTTOMAN

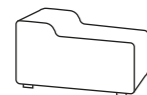

W 9"
H 22"
MH 26"
V613 CONSOLLE MINI STRAIGHT



W 9"
MW 16"
H 22"
MH 26"
V614 CONSOLLE MINI ANGLE



W 20"
H 22"
MH 26"
V621 CONSOLLE STRAIGHT



W 13"
MW 20"
H 22"
MH 26"
V620 CONSOLLE ANGLE

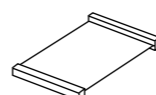

V701 TRAY CONSOLE



Foot Finishing Option

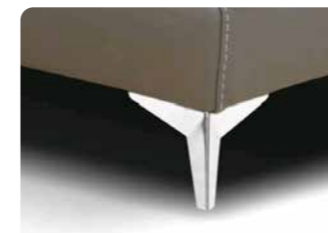

Foot Option 1:
Stainless Steel Finish



Foot Option 2:
Stainless Steel Bronze Finish

Thin stitch standard



Thick stitch option



Medusa

Technical Description

- thick stitch:** Available as option
- structure:** Hardwood frame for extra strength
- spring system:** Reinforced elastic webbing
- seat/back cushions:** High density Ecologic open-cell polyurethane foam covered with a layer of dacron wadding
- removability:** Not possible
- mechanisms:** Each seat has two separate motors, one for the headrest and one for the footrest
- battery pack:** Available as option
- usb port:** Available as option
- tray:** Wooden matt black finish is available upon request on the console
- foot option 2:** Stainless Steel Finish
- foot option 3:** Stainless Steel Bronze Finish

LEATHER COLOR SHADE DIFFERENCES: The model upholstered with some Natural leather such as Maya, Moss, Carees and Sensation, could present in some area differences in color tones of about 5%. Such differences are not to be considered defect but an expression of the natural characteristic of the cowhide. The company reserves the right without prior notice to make technical sheets changes and/or materials for quality product improvement. Leather sofas are a handmade product and according to the leather covering selected there could be a measurement tolerance of about 2 inches (cm 5) on each sku.
REV. 002 DEL 28/10/2020 | Pag. 2 of 2

Millenium

Endless possibilities to combine the modules of this sofa and adapt them to your space. Two different mechanisms, one to relax the head, the other for the feet. One, style, unique.



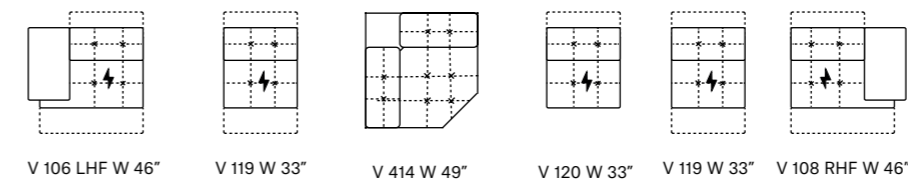
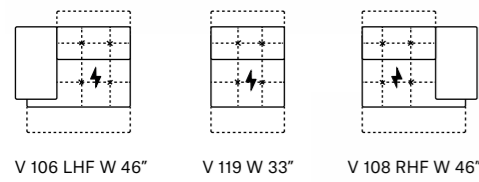

Millenium

Millenium is a power motion model with wide seats featuring topstitching on the seat and back cushions. The armrest exterior is skillfully designed to create a break with the main structure. Millenium is equipped with a state of the art power mechanism and touchpad that individually controls headrest and footrest, allowing maximum comfort and support for your head, back and legs. This model is available with two seat width options and it's modularity allows to make any size sofa or sectional..



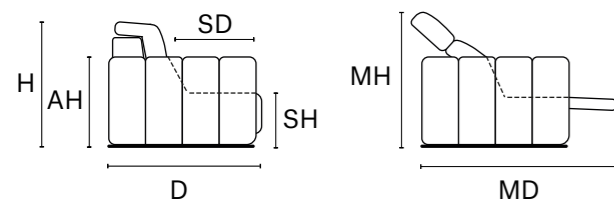

D 43" MD 62" H 33" AH 22" SH 17" SD 22" MH 40"

MAXI SEAT (version of the group have the same seat width)

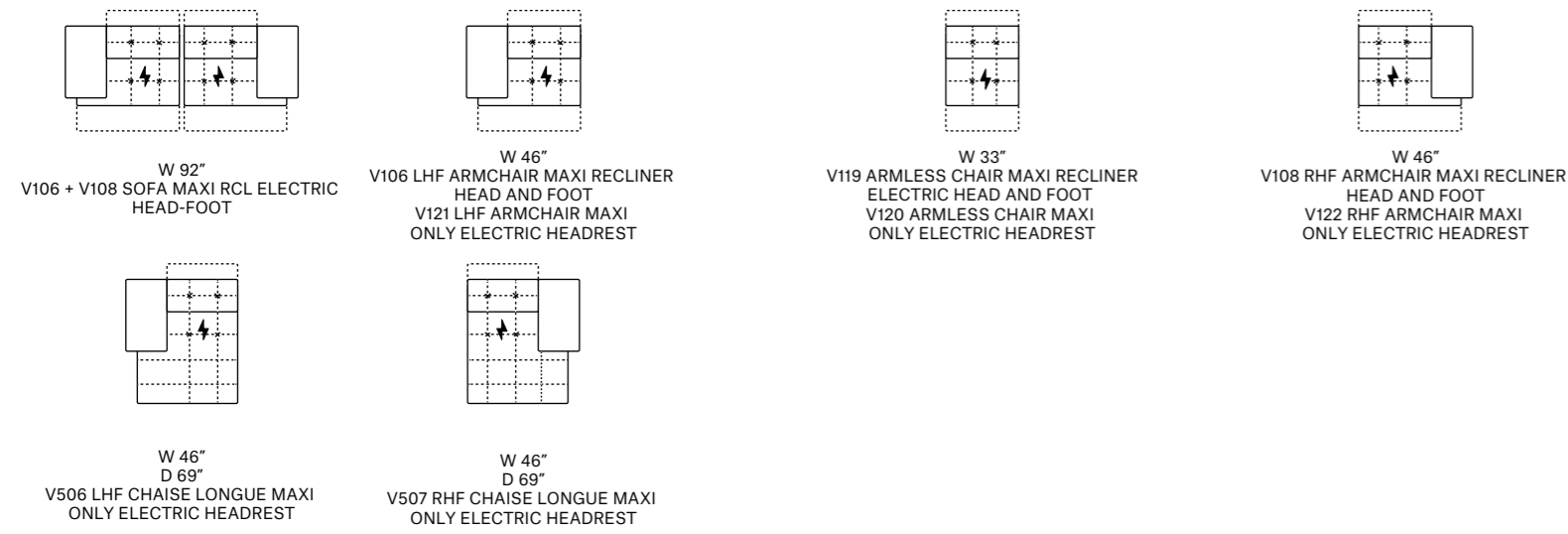

MINI SEAT (version of the group have the same seat width)

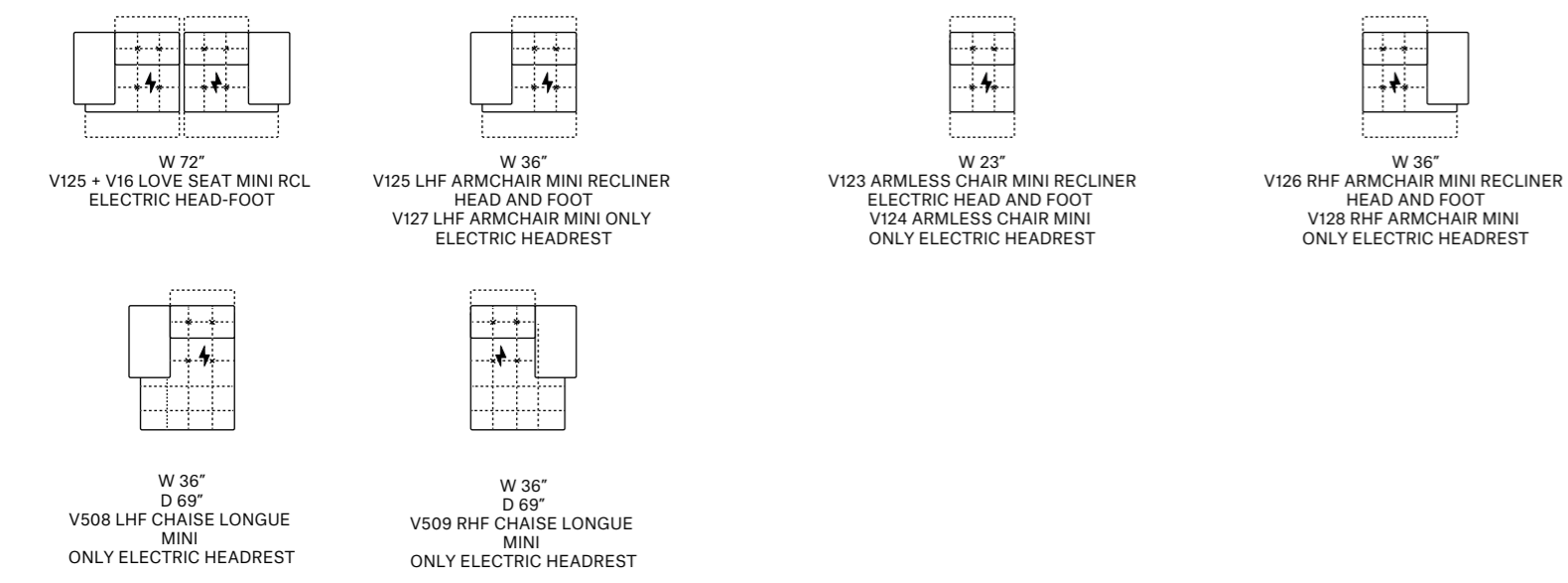

JOLLY (can be combined with all the version group)

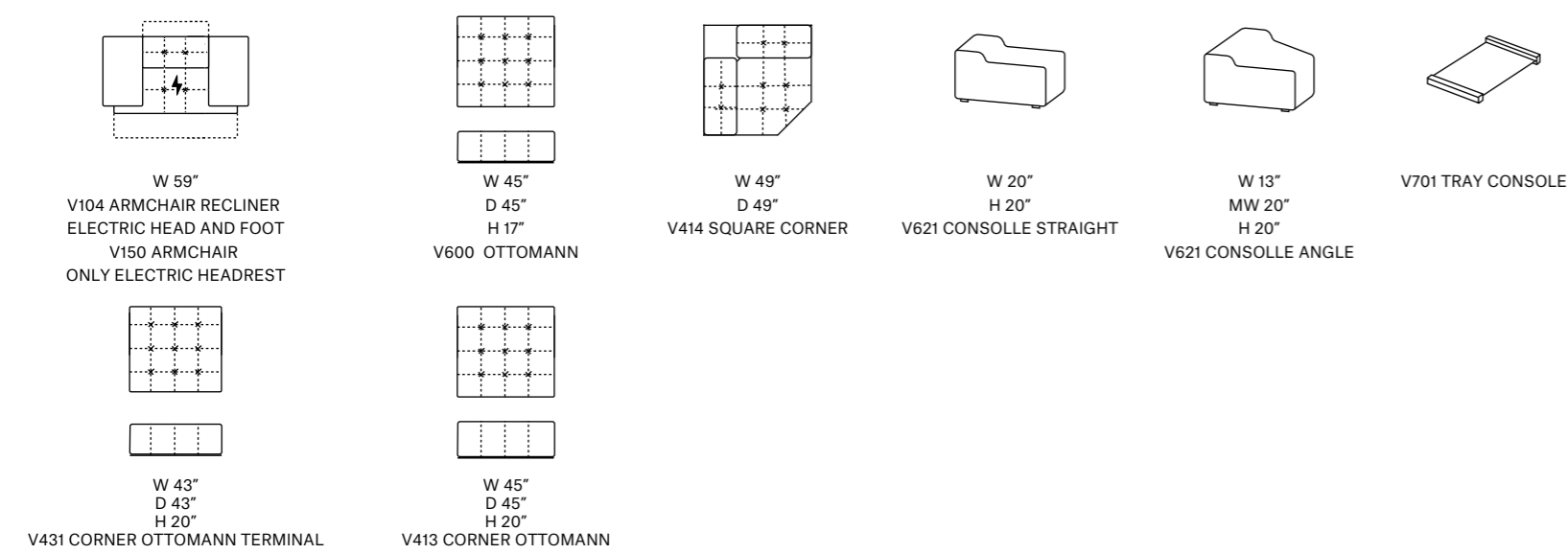

Foot Finishing Option



Foot Option 1:
Stainless Steel Finish

Foot Option 2:
Stainless Steel Bronze Finish

Thin stitch standard

Thick stitch option



Millennium

Technical Description

- thick stitch:** Available as option
- spring system:** Reinforced elastic webbing
- structure:** Hardwood frame for extra strength
- seat/back cushions:** Hight density Ecologic open-cell polyurethane foam covered with a layer of dacron wadding.
- removability:** Not possible
- mechanisms:** Each seat has two separate motors, one for the headrest and one for the footrest
- base option # 1:** Stainless Steel Finish
- base option # 2:** Stainless Steel Bronze Finish
- usb:** Available as option
- battery pack:** Available as option

LEATHER COLOR SHADE DIFFERENCES: The model upholstered with some Natural leather such as Maya, Moss, Carees and Sensation, could present in some area differences in color tones of about 5%. Such differences are not to be considered defect but an expression of the natural characteristic of the cowhide. The company reserves the right without prior notice to make technical sheets changes and/or materials for quality product improvement. Leather sofas are a handmade product and according to the leather covering selected there could be a measurement tolerance of about 2 inches (cm 5) on each sku.
REV. 002 DEL 28/10/2020 | Pag. 2 of 2

Morfeo

Circular motifs and rounded forms for this sofa that promises a comfortable embrace at first sight. With the motion system, comfort is also technological and allows relaxation of the head, back, and legs.



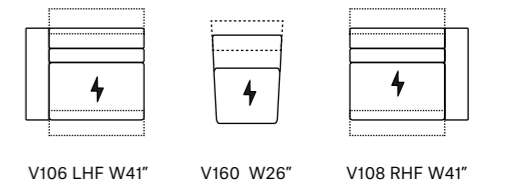
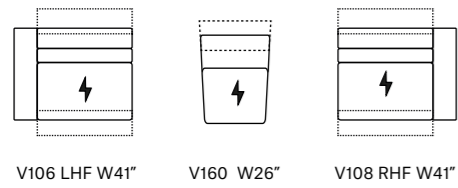

Morfeo

Morfeo is a power motion with a sophisticated thin arm that easily adapts to all living spaces. Morfeo is equipped with a state of the art power mechanism and touchpad that individually controls headrest and footrest allowing maximum comfort and support for your head, back and legs even for the tallest people. This model is available with two seat width options and it's modularity allows to make any size sofa or sectional.

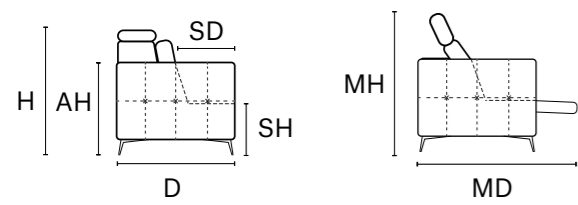

D 44" MD 71" H 35" AH 26" SH 19" SD 22" MH 41"

MAXI SEAT (version of the group have the same seat width)

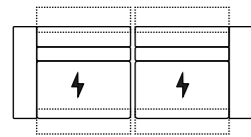

W 83"
V 106 + V 108 SOFA MAXI RCL
ELECTRIC HEAD-FOOT

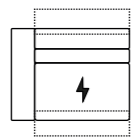

W 41"
V 106 LHF ARMCHAIR MAXI RECLINER
HEAD AND FOOT
V 121 LHF ARMCHAIR MAXI
ONLY ELECTRIC HEADREST

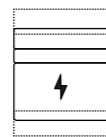

W 33"
V 119 ARMLESS CHAIR MAXI RECLINER
ELECTRIC HEAD AND FOOT
V 120 ARMLESS CHAIR MAXI
ONLY ELECTRIC HEADREST

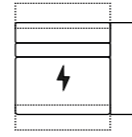

W 41"
V 108 RHF ARMCHAIR MAXI RECLINER
HEAD AND FOOT
V 122 RHF ARMCHAIR MAXI
ONLY ELECTRIC HEADREST

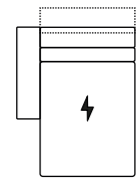

W 41"
D 69"
V 506 LHF CHAISE LOUNGE MAXI
ONLY ELECTRIC HEADREST

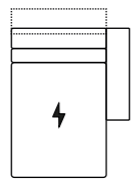

W 41"
D 69"
V 507 RHF CHAISE LOUNGE MAXI
ONLY ELECTRIC HEADREST

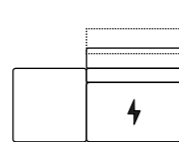

W 61"
V 166 LHF CHAIR MAXI MERIDIAN
ONLY ELECTRIC HEADREST

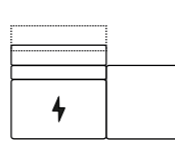

W 61"
V 167 RHF CHAIR MAXI MERIDIAN
ONLY ELECTRIC HEADREST

SMALL SEAT (version of the group have the same seat width)

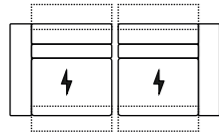

W 70"
V 125 + V 126 LOVESEAT MAXI RCL
ELECTRIC HEAD-FOOT

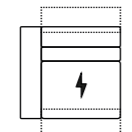

W 35"
V 125 LHF ARMCHAIR MINI RECLINER
ELECTRIC HEAD AND FOOT
V 127 LHF ARMCHAIR MINI
ONLY ELECTRIC HEADREST

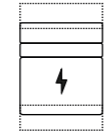

W 28"
V 123 ARMLESS CHAIR MINI RECLINER
ELECTRIC HEAD AND FOOT
V 124 ARMLESS CHAIR MINI
ONLY ELECTRIC HEADREST

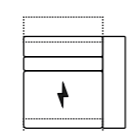

W 35"
V 126 RHF ARMCHAIR MINI RECLINER
ELECTRIC HEAD AND FOOT
V 128 RHF ARMCHAIR MINI
ONLY ELECTRIC HEADREST

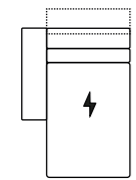

W 35"
D 69"
V 508 LHF CHAISE
LOUNGE MINI
ONLY ELECTRIC HEADREST

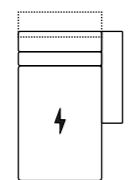

W 35"
D 69"
V 509 RHF CHAISE
LOUNGE MINI
ONLY ELECTRIC HEADREST

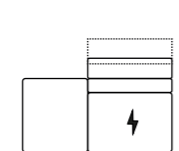

W 56"
V 168 LHF CHAIR MINI MERIDIAN
ONLY ELECTRIC HEADREST

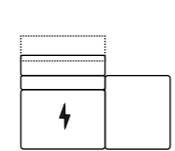

W 56"
V 169 RHF CHAIR MINI MERIDIAN
ONLY ELECTRIC HEADREST

JOLLY (can be combined with all the version group)

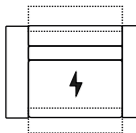

W 44"
V 104 ARMCHAIR RECLINER
ELECTRIC HEAD AND FOOT
V 150 ARMCHAIR
ONLY ELECTRIC HEADREST

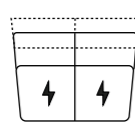

W 52"
MW 65"
V 251 LOVESEAT ARMLESS ANGLED
ONLY ELECTRIC HEADREST

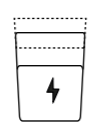

W 26"
MW 39"
V 160 ARMLESS CHAIR MAXI ANGLED
ONLY ELECTRIC HEADREST

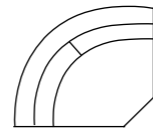

W 54"
D 54"
V 400 ROUND CORNER

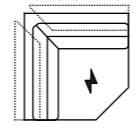

W 54"
D 54"
V 415 SQUARE CORNER
ELECTRIC HEADREST

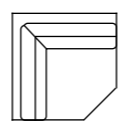

W 54"
D 54"
V 414 SQUARE CORNER

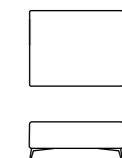

W 35"
D 30"
V 600 OTTOMAN



W 9"
H 22"
MH 26"
V 613 CONSOLLE MINI STRAIGHT

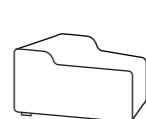

W 9"
MW 16"
H 22"
MH 26"
V 614 CONSOLLE MINI ANGLE

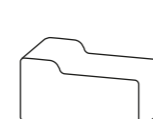

W 20"
H 22"
MH 26"
V 621 CONSOLLE STRAIGHT



W 13"
H 22"
MW 20"
MH 26"
V 620 CONSOLLE ANGLE

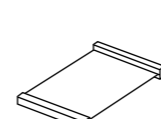

V 701 TRAY CONSOLLE



Foot Finishing Option



Foot Option 1:
Stainless Steel



Foot Option 2:
Stainless Steel Bronze Finish

Thin stitch standard



Thick stitch option



Morfeo

Technical Description

- thick stitch:** Available as option
- structure:** Hardwood frame for extra strenght
- seat/back suspension:** Reinforced elastic webbing
- seat/back cushions:** Hight density ecologic Ecologic open-cell polyurethane foam covered with a layer of dacron wadding.
- removability:** Not available
- mechanisms:** Each seat has two separate motors, one for the headrest and one for the footrest
- battery pack:** Available as option
- tray:** Wooden matt black finishing, upon request on consolle
- foot option # 1 :** Stainless steel feet
- foot option # 2 :** Metal feet bronze finish
- usb :** Available as option

LEATHER COLOR SHADE DIFFERENCES: The model upholstered with some Natural leather such as Maya, Moss, Carees and Sensation, could present in some area differences in color tones of about 5%. Such differences are not to be considered defect but an expression of the natural characteristic of the cowhide. The company reserves the right without prior notice to make technical sheets changes and/or materials for quality product improvement. Leather sofas are a handmade product and according to the leather covering selected there could be a measurement tolerance of about 2 inches (cm 5) on each sku.
REV. 002 DEL 28/10/2020 | Pag. 2 of 2



Olimpo

Minimalist sensitivity and the power of comfort. A single touch to amplify the relaxation of body and mind, while the harmonious, classic, timeless style takes care of the eyes.

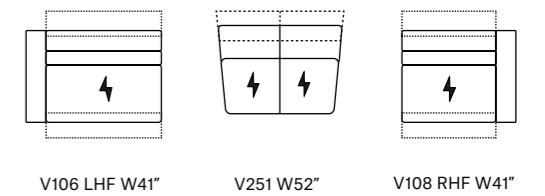
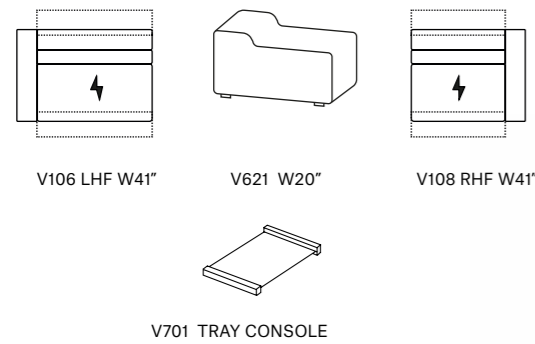

Olimpo

Olimpo is a power motion with a sophisticated thin arm that easily adapts to all living spaces. Olimpo is equipped with a state of the art power mechanism and touchpad that individually controls headrest and footrest allowing maximum comfort and support for your head, back and legs even for the tallest people. This model is available with two seat width options and it's modularity allows to make any size sofa or sectional.

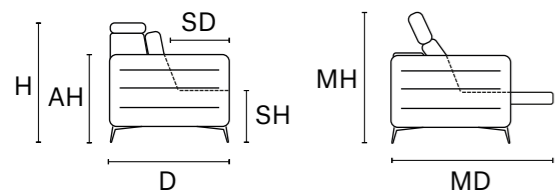

D 44" MD 71" H 35" AH 26" SH 19" SD 22" MH 41"

MAXI SEAT (version of the group have the same seat width)

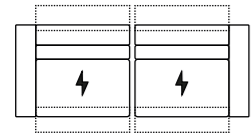

W 82"
V 106 + V108 SOFA MAXI RCL
ELECTRIC HEAD-FOOT

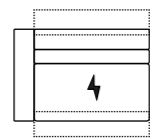

W 41"
V106 LHF ARMCHAIR MAXI RECLINER
HEAD AND FOOT
V121 LFH ARMCHAIR MAXI
ONLY ELECTRIC HEADREST

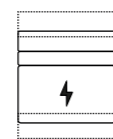

W 33"
V119 ARMLESS CHAIR MAXI RECLINER
ELECTRIC HEAD AND FOOT
V120 ARMLESS CHAIR MAXI
ONLY ELECTRIC HEADREST

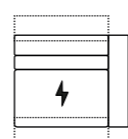

W 41"
V108 RHF ARMCHAIR MAXI RECLINER
HEAD AND FOOT
V122 RHF ARMCHAIR MAXI
ONLY ELECTRIC HEADREST

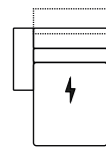

W 41"
MD 69"
V 506 LHF CHAISE LOUNGE MAXI
ONLY ELECTRIC HEADREST

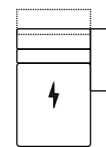

W 41"
MD 69"
V 507 RHF CHAISE LOUNGE MAXI
ONLY ELECTRIC HEADREST

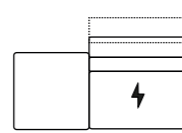

W 61"
V 166 LHF CHAIR MAXI MERIDIAN
ONLY ELECTRIC HEADREST

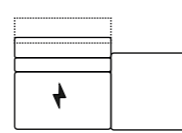

W 61"
V 167 RHF CHAIR MAXI MERIDIAN
ONLY ELECTRIC HEADREST

MINI SEAT (version of the group have the same seat width)

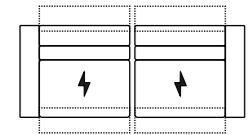

W 70"
V 125 + V 126 LOVESEAT MINI RCL
ELECTRIC HEAD-FOOT

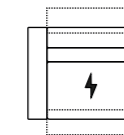

W 35"
V125 LHF ARMCHAIR MINI RECLINER
ELECTRIC HEAD AND FOOT
V127 LHF ARMCHAIR MINI
ONLY ELECTRIC HEADREST

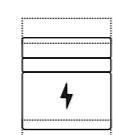

W 28"
V123 ARMLESS CHAIR MINI RECLINER
ELECTRIC HEAD AND FOOT
V124 ARMLESS CHAIR MINI
ONLY ELECTRIC HEADREST

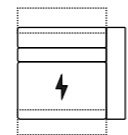

W 35"
V126 RHF ARMCHAIR MINI RECLINER
ELECTRIC HEAD AND FOOT
V128 RHF ARMCHAIR MINI
ONLY ELECTRIC HEADREST

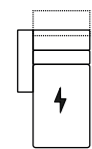

W 36"
MD 69"
V 508 LHF CHAISE
LOUNGE MINI
ONLY ELECTRIC HEADREST

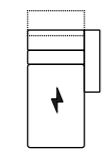

W 35"
MD 69"
V509 RHF CHAISE
LOUNGE MINI
ONLY ELECTRIC HEADREST

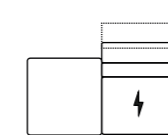

W 56"
V168 LHF CHAIR MINI MERIDIAN
ONLY ELECTRIC HEADREST

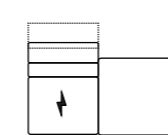

W 56"
V169 RHF CHAIR MINI MERIDIAN
ONLY ELECTRIC HEADREST

JOLLY (can be combined with all the version group)

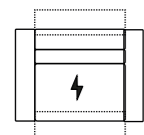

W 44"
V104 ARMCHAIR RECLINER
ELECTRIC HEAD AND FOOT
V150 ARMCHAIR
ONLY ELECTRIC HEADREST

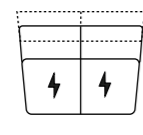

W 52"
MW 65"
V251 LOVESEAT ARMLESS ANGLE
ONLY ELECTRIC HEADREST

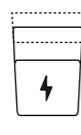

W 26"
MW 39"
V160 ARMLESS CHAIR MAXI ANGLED
ONLY ELECTRIC HEADREST

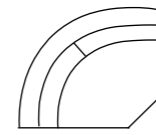

W 54"
D 54"
V 400 ROUND CORNER

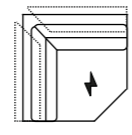

W 54"
D 54"
V 415 SQUARE CORNER
ELECTRIC HEADREST

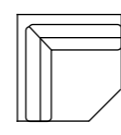

W 54"
D 54"
V 414 SQUARE CORNER

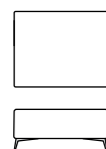

W 35"
D 30"
V600 OTTOMAN

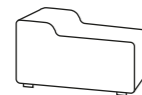

W 9"
H 22"
MH 26"
V613 CONSOLLE MINI STRAIGHT



W 9"
MW 16"
H 22"
MH 26"
V614 CONSOLLE MINI ANGLE



W 20"
H 22"
MH 26"
V621 CONSOLLE STRAIGHT

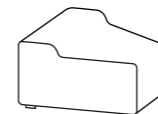

W 13"
H 22"
MW20"
MH 26"
V620 CONSOLLE ANGLE

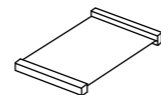

V701 TRAY CONSOLE



Foot Finishing Option



Foot Option 1:
Stainless Steel Finish



Foot Option 2:
Stainless Steel Bronze Finish

Thin stitch standard



Thick stitch option



Decor Stich Option



Decor stitch:
Tipe A

Olimpo

Technical Description

- decor stitch type:** "A" Available as option
- thick stitch:** Available as option
- structure:** Hardwood frame for extra strenght
- spring system:** Reinforced elastic webbing
- seat/back cushions:** High density Ecologic open-cell polyurethane foam covered with a layer of dacron wadding.
- removability:** Not available
- mechanisms:** Each seat has two separate motors, one for the headrest and one for the footrest
- usb:** Available as option
- battery pack:** Available as option
- tray:** Wooden matt black finish, upon request on consolle
- foot option # 1 :** Stainless steel finish
- foot option # 2 :** Stainless steel Bronze finish

LEATHER COLOR SHADE DIFFERENCES: The model upholstered with some Natural leather such as Maya, Moss, Carees and Sensation, could present in some area differences in color tones of about 5%. Such differences are not to be considered defect but an expression of the natural characteristic of the cowhide. The company reserves the right without prior notice to make technical sheets changes and/or materials for quality product improvement. Leather sofas are a handmade product and according to the leather covering selected there could be a measurement tolerance of about 2 inches (cm 5) on each sku.
REV. 002 DEL 28/10/2020 | Pag. 2 of 2

Paky

A triumph of comfort, this sofa with its internal mechanisms faithfully follows the body's contours and offers absolute rest. Comfort interpreted in an urban/contemporary key.



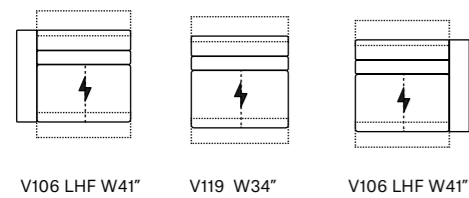

V106 LHF W41" V119 W34" V106 LHF W41"



Paky

Paky is a timeless power motion designed to guarantee a sophisticated elegant look, comfort and relaxation. Paky is equipped with a state of the art power mechanism and touchpad that individually controls headrest and footrest allowing maximum comfort and support for your head, back and legs even for the tallest people. This model is available with two seat width options and it's modularity allows to make any size sofa or sectional. In addition, the seat and back is composed of memory foam and the extreme soft seating comfort perfectly adapts to the body.

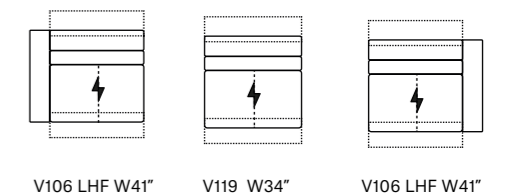

V106 LHF W41" V119 W34" V106 LHF W41"



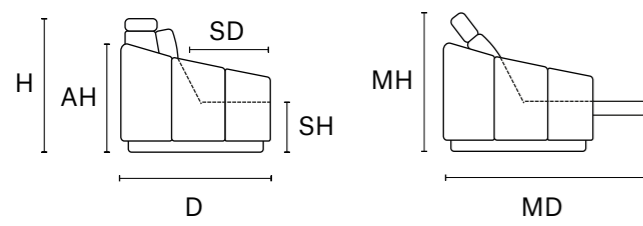

D 44" MD 67" H 33" AH 26" SH 19" SD 23" MH 41"

MAXI SEAT (version of the group have the same seat width)

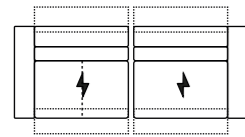

W 82"
V 106 + V108 SOFA MAXI RCL
ELECTRIC HEAD-FOOT

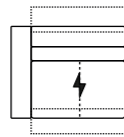

W 41"
V106 LHF ARMCHAIR MAXI RECLINER
ELECTRIC HEAD AND FOOT
V121 LHF ARMCHAIR MAXI
ONLY ELECTRIC HEADREST

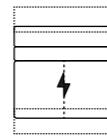

W 34"
V119 ARMLESS CHAIR MAXI RECLINER
ELECTRIC HEAD AND FOOT
V120 ARMLESS CHAIR MAXI
ONLY ELECTRIC HEADREST

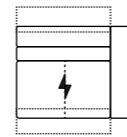

W 41"
V108 RHF ARMCHAIR MAXI RECLINER
ELECTRIC HEAD AND FOOT
V122 RHF ARMCHAIR MAXI
ONLY ELECTRIC HEADREST

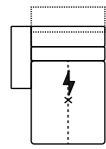

W 41"
D 69"
V 506 LHF CHAISE LOUNGE MAXI
ONLY ELECTRIC HEADREST

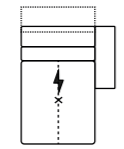

W 41"
D 69"
V 507 RHF CHAISE LONGUE MAXI
ONLY ELECTRIC HEADREST

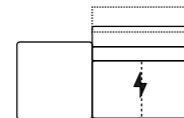

W 61"
V 166 LHF CHAIR MAXI MERIDIAN
ONLY ELECTRIC HEADREST

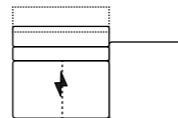

W 61"
V 167 RHF CHAIR MAXI MERIDIAN
ONLY ELECTRIC HEADREST

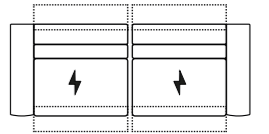

W82"
V106+V108 SOFA MAXI RCL ELECTRIC
HEAD - FOOT

MINI SEAT (version of the group have the same seat width)

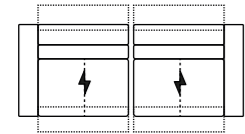

W 70"
V 125 + V 126 LOVE SEAT MINI RCL
ELECTRIC HEAD-FOOT

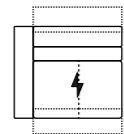

W 35"
V125 LHF ARMCHAIR MINI RECLINER
ELECTRIC HEAD AND FOOT
V127 LHF ARMCHAIR MINI
ONLY ELECTRIC HEADREST

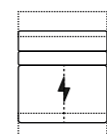

W 28"
V123 ARMLESS CHAIR MINI RECLINER
ELECTRIC HEAD AND FOOT
V124 ARMLESS CHAIR MINI
ONLY ELECTRIC HEADREST

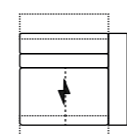

W 35"
V126 RHF ARMCHAIR MINI RECLINER
ELECTRIC HEAD AND FOOT
V128 RHF ARMCHAIR MINI
ONLY ELECTRIC HEADREST

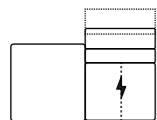

W 55"
V168 LHF CHAIR MINI MERIDIAN
ONLY ELECTRIC HEADREST

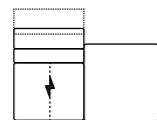

W 55"
V169 RHF CHAIR MINI MERIDIAN
ONLY ELECTRIC HEADREST

JOLLY (can be combined with all the version group)

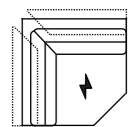

W 54"
D 54"
V415 SQUARE CORNER
ELECTRIC HEADREST

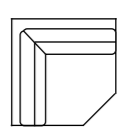

W 54"
D 54"
V414 SQUARE CORNER

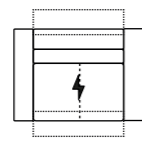

W 40"
V104 ARMCHAIR RECLINER
ELECTRIC HEAD AND FOOT
V150 ARMCHAIR
ONLY ELECTRIC HEADREST

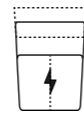

W 26"
MW 39"
V160 ARMLESS CHAIR MAXI ANGLED
ONLY ELECTRIC HEADREST

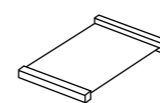

V701 TRAY CONSOLE

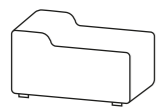

W 20"
H 22"
MH 26"
V621 CONSOLLE STRAIGHT

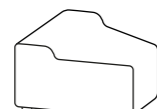

W 13"
MW 20"
H 22"
MH 26"
V620 CONSOLLE ANGLE

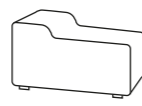

W 9"
H 22"
MH 26"
V613 CONSOLLE
MINI STRAIGHT

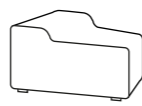

W 9"
MW 16"
H 22"
MH 26"
V614 CONSOLLE MINI ANGLE



Foot Finishing Option



Foot Option 1:
Stainless Steel Finish



Foot Option 2:
Stainless Steel Bronze Finish

Thin stitch standard



Thick stitch option



Paky

Technical Description

- thick stitch:** Available as option
- structure:** Hardwood frame for extra strenght
- seat/back suspension:** Reinforced elastic webbing
- seat/back cushions:** High density ecologic polyurethane foam with coil springs built inside the cushion covered with a layer of memory foam on top
- removability:** Not available
- mechanisms:** Each seat has two separate motors, one for the headrest and one for the footrest
- battery packs:** Available as option
- usb port:** Available as option
- cup holder:** Available as option on V614 and V613
- foot option 1:** Stainless Steel Finish
- foot option 2:** Stainless Steel Bronze Finish

LEATHER COLOR SHADE DIFFERENCES: The model upholstered with some Natural leather such as Maya, Moss, Carees and Sensation, could present in some area differences in color tones of about 5%. Such differences are not to be considered defect but an expression of the natural characteristic of the cowhide. The company reserves the right without prior notice to make technical sheets changes and/or materials for quality product improvement. Leather sofas are a handmade product and according to the leather covering selected there could be a measurement tolerance of about 2 inches (cm 5) on each sku.



Smart

Wonderful comfort, with adjustable headrest, footrest and armrests, spacious seats with precious padding materials, visible hand-stitched seams, feet available in two finishes.
Yes, wonderful.

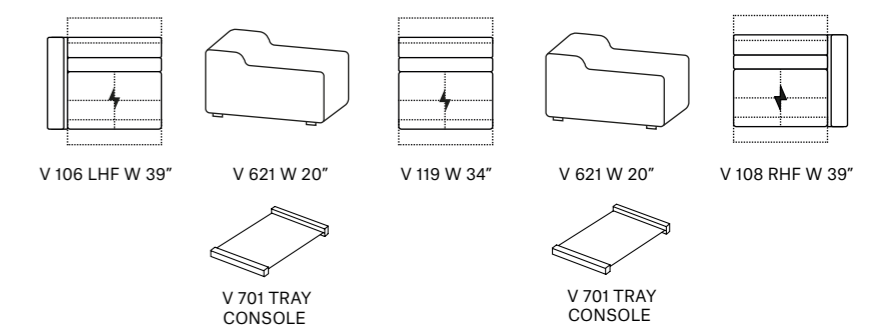
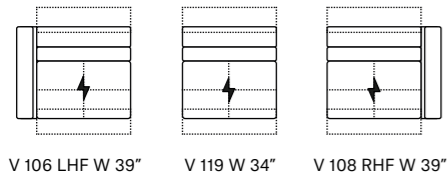

Smart

Smart is a unique power motion designed to guarantee a sophisticated elegant look, comfort and relaxation. Smart is equipped with a state of the art power mechanism and touchpad that individually controls headrest and footrest allowing maximum comfort and support for your head, back and legs even for the tallest people. This model is available with two seat width options and it's modularity allows to make any size sofa or sectional. In addition, the seat and back is composed of memory foam and the extreme soft seating comfort perfectly adapts to the body. The armrests are adjustable and stop at the desired position.

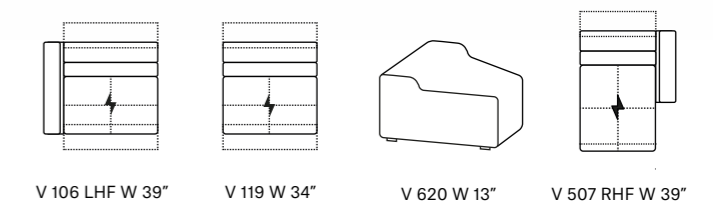

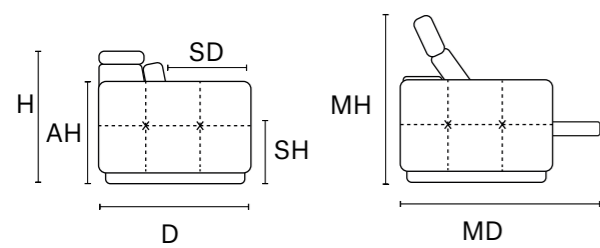

D 44" MD 67" H 33" AH 28" SH 19" SD 23" MH 41"

MAXI SEAT (version of the group have the same seat width)

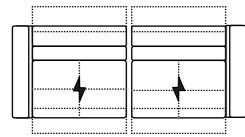

W 78"
MW 94"
V106+V108 SOFA MAXI RCL
ELECTRIC HEAD- FOOT

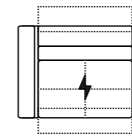

W 39"
MW 47"
V106 LHF ARMCHAIR MAXI RECLINER
HEAD AND FOOT
V 121 LHF ARMCHAIR MAXI
ONLY ELECTRIC HEADREST

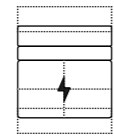

W 34"
V119 ARMLESS CHAIR MAXI
RECLINER ELECTRIC HEAD AND FOOT
V120 ARMLESS CHAIR MAXI
ONLY ELECTRIC HEADREST

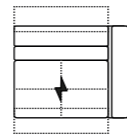

W 39"
MW 47"
V108 RHF ARMCHAIR MAXI RECLINER
HEAD AND FOOT
V 122 RHF ARMCHAIR MAXI
ONLY ELECTRIC HEADREST

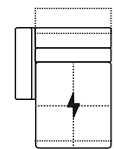

W 39"
MW 47"
D 69"
V506 LHF CHAISE LONGUE MAXI
ONLY ELECTRIC HEADREST

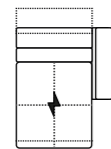

W 39"
MW 47"
D 69"
V507 RHF CHAISE LONGUE MAXI
ONLY ELECTRIC HEADREST



W 61"
V166 LHF CHAIR MAXI MERIDIAN
ONLY ELECTRIC HEADREST

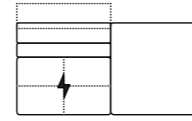

W 61"
V167 RHF CHAIR MAXI MERIDIAN
ONLY ELECTRIC HEADREST

MINI SEAT (version of the group have the same seat width)

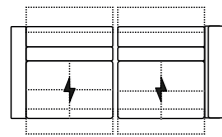

W 66"
W 83"
V125+V126 LOVE SEAT MINI
RCL ELECTRIC HEAD-FOOT

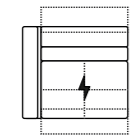

W 33"
MW 41"
V125 LHF ARMCHAIR MINI RECLINER
ELECTRIC HEAD AND FOOT
V 127 LHF ARMCHAIR MAXI
ONLY ELECTRIC HEADREST

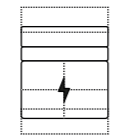

W 28"
V123 ARMLESS CHAIR MINI
RECLIER ELECTRIC HEAD AND FOOT
V124 ARMLESS CHAIR MINI
ONLY ELECTRIC HEADREST

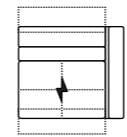

W 33"
MW 41"
V126 RHF ARMCHAIR MINI RECLINER
ELECTRIC HEAD AND FOOT
V 128 RHF ARMCHAIR MINI
ONLY ELECTRIC HEADREST

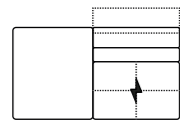

W 55"
V168 LHF CHAIR MINI MERIDIAN
ONLY ELECTRIC HEADREST

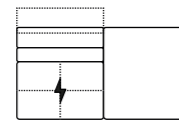

W 55"
V169 RHF CHAIR MINI MERIDIAN
ONLY ELECTRIC HEADREST

JOLLY (can be combined with all the version group)

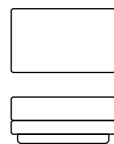

W 37"
D 26"
V600 OTTOMAN

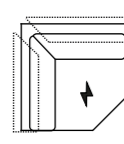

W 54"
D 54"
V415 SQUARE CORNER
ELECTRIC HEADREST

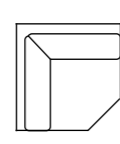

W 54"
D 54"
V414 SQUARE CORNER

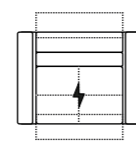

W 39"
MW 46"
V104 ARMCHAIR RECLINER
ELECTRIC HEAD AND FOOT
V150 ARMCHAIR
ONLY ELECTRIC HEADREST

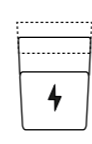

W 26"
MW 39"
V160 ARMLESS CHAIR MAXI ANGLED
ONLY ELECTRIC HEADREST

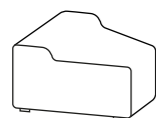

W 13"
MW 20"
H 22"
MH 26"
V620 CONSOLLE ANGLE

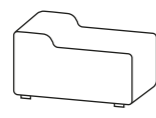

W 20"
H 22"
MH 26"
V621 CONSOLLE STRAIGHT

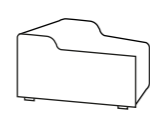

W 9"
MW 16"
H 22"
MH 26"
V614 CONSOLLE
MINI ANGLE

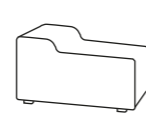

W 9"
H 22"
MH 26"
V613 CONSOLLE
MINI STRAIGHT

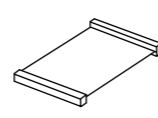

V701 TRAY CONSOLE



Foot Finishing Option



Foot Option 1:
Stainless Steel Finish



Foot Option 2:
Stainless Steel Bronze Finish

Smart

Technical Description

- special stitch:** Type "C" available as option
- thick stitch:** Available as option
- structure:** Hardwood frame for extra strength
- seat/back suspension:** Reinforced elastic webbing
- seat/back cushions:** High Density ecologic polyurethane foam with coil springs built inside the cushion covered with a layer of memory foam on top.
- removability:** Not available
- mechanisms :** Each seat has two separate motors, one for the headrest and one for the footrest
- battery packs:** Available as option
- usb port:** Not available
- foot option 1:** Stainless Steel Finish
- foot option 2:** Stainless Steel Bronze Finish

Thin stitch standard



Thick stitch option



Decor Stich Option



Decor stitch:
Type C

LEATHER COLOR SHADE DIFFERENCES: The model upholstered with some Natural leather such as Maya, Moss, Carees and Sensation, could present in some area differences in color tones of about 5%. Such differences are not to be considered defect but an expression of the natural characteristic of the cowhide. The company reserves the right without prior notice to make technical sheets changes and/or materials for quality product improvement. Leather sofas are a handmade product and according to the leather covering selected there could be a measurement tolerance of about 2 inches (cm 5) on each sku.



Style

A sofa that amazes and wins you over with its comfort. Starting with the wide armrests and ending with the possibility to adjust the entire seat to suit your comfort needs, thanks to the internal mechanism. Must-have.

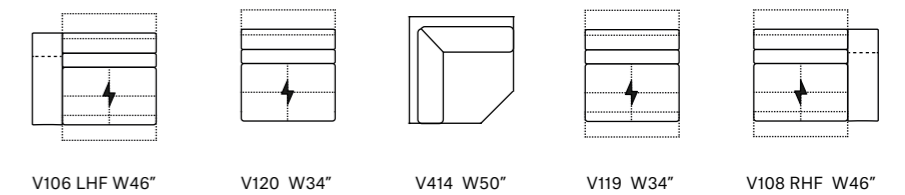
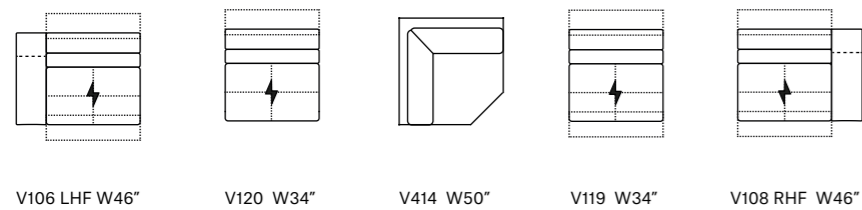

Style

Style is a unique power motion designed to guarantee a sophisticated elegant look, comfort and relaxation. Style is equipped with a state of the art power mechanism and touchpad that individually controls headrest and footrest allowing maximum comfort and support for your head, back and legs even for the tallest people. This model is available with two seat width options and it's modularity allows to make any size sofa or sectional. In addition, the seat and back is composed of memory foam and the extreme soft seating comfort perfectly adapts to the body.

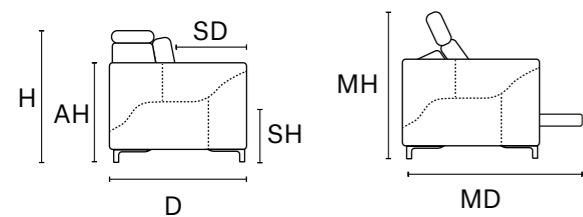

D 44" MD 67" H 33" AH 28" SH 19" SD 23" MH 41"

MAXI SEAT (version of the group have the same seat width)

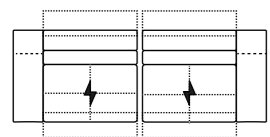

W 92"
V106+V108 SOFA MAXI RCL
ELECTRIC HEAD-FOOT

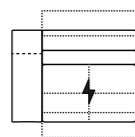

W 46"
V106 LHF ARMCHAIR MAXI RECLINER
HEAD AND FOOT
V 121 LHF ARMCHAIR MAXI ONLY
ELECTRIC HEADREST

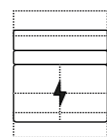

W 34"
V119 ARMLESS CHAIR MAXI
RECLIER ELECTRIC HEAD AND GOOT
V120 ARMLESS CHAIR MAXI ONLY
ELECTRIC HEADREST

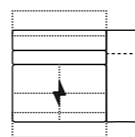

W 46"
V108 RHF ARMCHAIR MAXI RECLINER
HEAD AND FOOT
V 122 RHF ARMCHAIR MAXI ONLY
ELECTRIC HEADREST

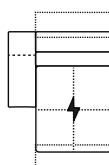

W 46"
D 69"
V506 LHF CHAISE LONGUE MAXI ONLY
ELECTRIC HEADREST

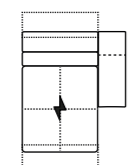

W 46"
D 69"
V507 RHF CHAISE LONGUE MAXI ONLY
ELECTRIC HEADREST

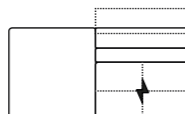

W 61"
V166 LHF CHAIR MAXI MERIDIAN
ONLY ELECTRIC HEADREST

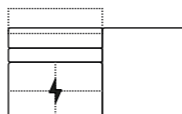

W 61"
V167 RHF CHAIR MAXI MERIDIAN
ONLY ELECTRIC HEADREST

MINI SEAT (version of the group have the same seat width)

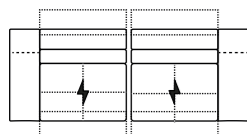

W 80"
V125+V126 LOVE SEAT MINI RCL
ELECTRIC HEAD-FOOT

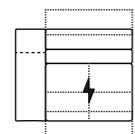

W 40"
V125 LHF ARMCHAIR MINI RECLINER
ELECTRIC HEAD AND FOOT
V 127 LHF ARMCHAIR MINI ONLY
ELECTRIC HEADREST

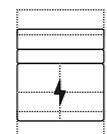

W 28"
V123 ARMLESS CHAIR MAXI
RECLIER ELECTRIC HEAD AND GOOT
V124 ARMLESS CHAIR MINI ONLY
ELECTRIC HEADREST

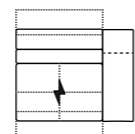

W 40"
V126 RHF ARMCHAIR MINI RECLINER
ELECTRIC HEAD AND FOOT
V 128 RHF ARMCHAIR MINI ONLY
ELECTRIC HEADREST

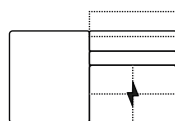

W 55"
V168 LHF CHAIR MAXI MERIDIAN
ONLY ELECTRIC HEADREST

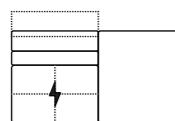

W 55"
V169 RHF CHAIR MAXI MERIDIAN
ONLY ELECTRIC HEADREST

JOLLY (can be combined with all the version group)

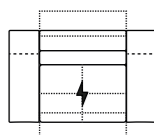

W 52"
V104 ARMCHAIR RECLINER ELECTRIC
HEAD AND FOOT
V150 ARMCHAIR ONLY ELECTRIC
HEADREST

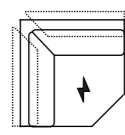

W 54"
D 54"
V415 SQUARE CORNER
ELECTRIC HEADREST

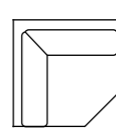

W 54"
D 54"
V414 SQUARE CORNER

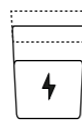

W 26"
MW 39"
V160 ARMLESS CHAIR MAXI ANGLED
ONLY ELECTRIC HEADREST

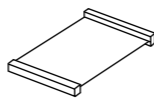

V701 TRAY CONSOLE

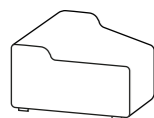

W 13"
MW 20"
H 22"
MH 26"
V620 CONSOLLE ANGLE

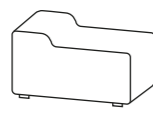

W 20"
H 22"
MH 26"
V621 CONSOLLE STRAIGHT



W 9"
MW 16"
H 22"
MH 26"
V614 CONSOLLE
MINI ANGLE

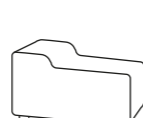

W 9"
H 22"
MH 26"
V613 CONSOLLE
MINI STRAIGHT



Foot Finishing Option



Foot Option 1:
Stainless Steel Finish



Foot Option 2:
Stainless Steel Bronze Finish

Thin stitch standard



Thick stitch option



Style

Technical Description

- thick stitch:** Available as option
- structure:** Hardwood frame for extra strenght
- seat/back suspension :** Reinforced elastic webbing
- seat/back cushions:** High density ecologic polyurethane foam with coil springs built inside the cushion covered with a layer of memory foam on top
- removability:** Not available
- mechanisms:** Each seat has two separate motors, one for the headrest and one for the footrest
- battery pack:** Available as option
- usb port:** Available as option
- foot option # 1:** Stainless steel Finish
- foot option # 2:** Stainless steel Bronze Finish

LEATHER COLOR SHADE DIFFERENCES: The model upholstered with some Natural leather such as Maya, Moss, Carees and Sensation, could present in some area differences in color tones of about 5%. Such differences are not to be considered defect but an expression of the natural characteristic of the cowhide. The company reserves the right without prior notice to make technical sheets changes and/or materials for quality product improvement. Leather sofas are a handmade product and according to the leather covering selected there could be a measurement tolerance of about 2 inches (cm 5) on each sku.
REV. 002 DEL 28/10/2020 | Pag. 2 of 2

Tony

Model Tony is comfort brought to the maximum level. The stitchings emphasize the soft design, while the supporting areas such as seats and backs emphasize the personality and refinement. Inside a technology heart.



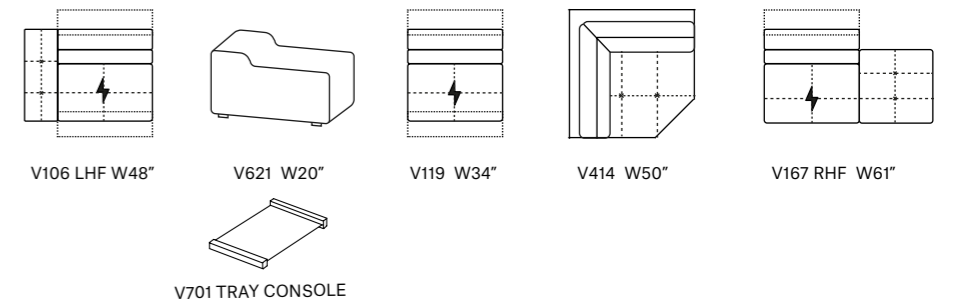
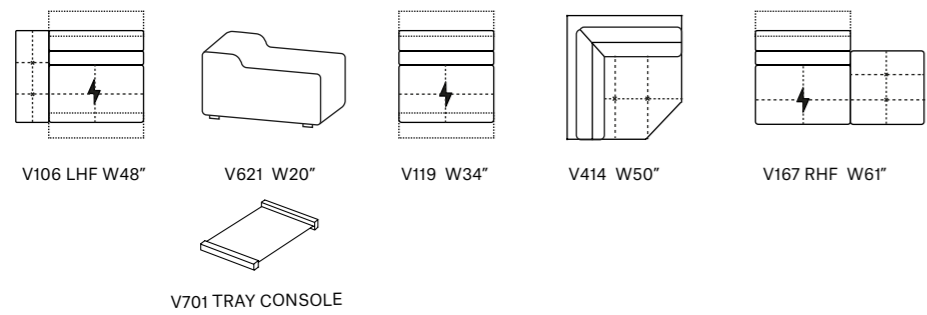

Tony

Tony is a power motion with a transitional modern look which easily adapts to all living spaces. Tony is equipped with a state of the art power mechanism and touchpad that individually controls headrest and footrest allowing maximum comfort and support for your head, back and legs. This model is available with two seat width options and it's modularity allows to make any size sofa or sectional. In addition, the seat and back is composed of memory foam and the extreme soft seating comfort perfectly adapts to the body.

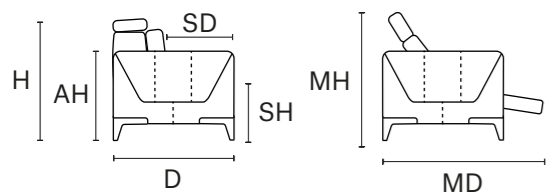

D 44" MD 67" H 33" AH 24" SH 19" SD 23" MH 41"

MAXI SEAT (version of the group have the same seat width)

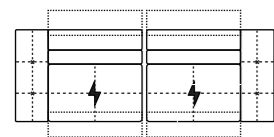

W 96"
V 106 + V108 SOFA MAXI RCL
ELETRIC HEAD-FOOT

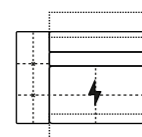

W 48"
V106 LHF ARMCHAIR MAXI RECLINER
ELETRIC HEAD AND FOOT
V121 LHF ARMCHAIR MAXI
ONLY ELETRIC HEADREST

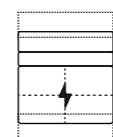

W 34"
V119 ARMLESS CHAIR MAXI RECLINER
ELETRIC HEAD AND FOOT
V120 ARMLESS CHAIR MAXI
ONLY ELETRIC HEADREST

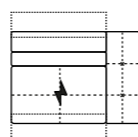

W 48"
V108 RHF ARMCHAIR MAXI RECLINER
ELETRIC HEAD AND FOOT
V122 RHF ARMCHAIR MAXI
ONLY ELETRIC HEADREST

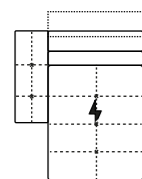

W 48"
D 69"
V 506 LHF CHAISE LOUNGE MAXI
ONLY ELETRIC HEADREST

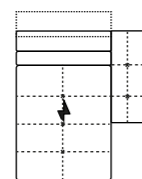

W 48"
D 69"
V 507 RHF CHAISE LOUNGE MAXI
ONLY ELETRIC HEADREST

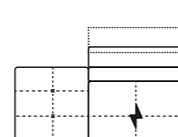

W 61"
V 166 LHF CHAIR MAXI MERIDIAN
ONLY ELETRIC HEADREST

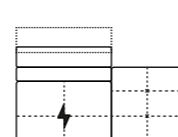

W 61"
V 167 RHF CHAIR MAXI MERIDIAN
ONLY ELETRIC HEADREST

MINI SEAT (version of the group have the same seat width)

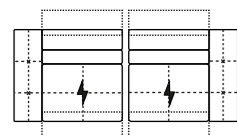

W 84"
V 125 + V 126 LOVESEAT MINI RCL
ELETRIC HEAD-FOOT

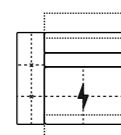

W 42"
V125 LHF ARMCHAIR MINI RECLINER
ELETRIC HEAD AND FOOT
V127 LHF ARMCHAIR MINI ONLY
ELETRIC HEADREST

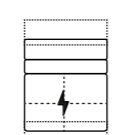

W 28"
V123 ARMLESS CHAIR MINI RECLINER
ELETRIC HEAD AND FOOT
V124 ARMLESS CHAIR MINI ONLY
ELETRIC HEADREST

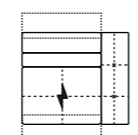

W 42"
V126 RHF ARMCHAIR MINI RECLINER
ELETRIC HEAD AND FOOT
V128 RHF ARMCHAIR MINI ONLY
ELETRIC HEADREST

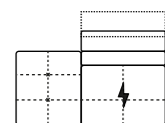

W 55"
V168 LHF CHAIR MINI MERIDIAN
ONLY ELETRIC HEADREST

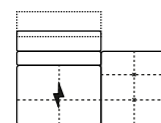

W 55"
V169 RHF CHAIR MINI MERIDIAN
ONLY ELETRIC HEADREST

JOLLY (can be combined with all the version group)

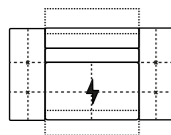

W 56"
V104 ARMCHAIR RECLINER ELETRIC
HEAD AND FOOT
V 150 ARMCHAIR
ONLY ELETRIC HEADREST

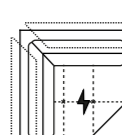

W 54"
D 54"
V415 SQUARE CORNER
ELETRIC HEADREST

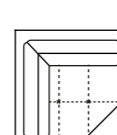

W 54"
D 54"
V414 SQUARE CORNER

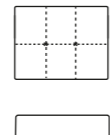

W 37"
D 26"
V600 OTTOMAN

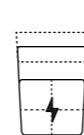

W 26"
MW 39"
V 160 ARMLESS
CHAIR MAXI ANGLED
ONLY ELETRIC HEADREST

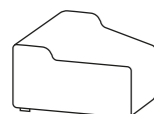

W 13"
MW 20"
H 22"
MH 26"
V620 CONSOLLE ANGLE

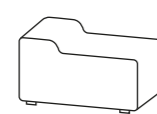

W 20"
H 22"
MH 26"
V621 CONSOLLE STRAIGHT

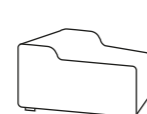

W 9"
MW 16"
H 22"
MH 26"
V614 CONSOLLE MINI ANGLE

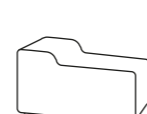

W 9"
H 22"
MH 26"
V613 CONSOLLE MINI STRAIGHT

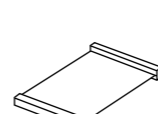

V701 TRAY CONSOLE



Foot Finishing Option



Foot Option 1:
Stainless Steel Finish



Foot Option 2:
Stainless Steel Bronze Finish

Thin stitch standard



Thick stitch option



Tony

Technical Description

- thick stitch:** Available as option
- structure:** Hardwood frame for extra strenght
- seat/back suspension :** Reinforced elastic webbing
- seat/back cushions:** High density ecologic polyurethane foam with coil springs built inside the cushion covered with a layer of memory foam on top
- removability:** Not possible
- mechanisms:** Each seat has two separate motors, one for the headrest and one for the footrest
- battery pack:** Available as option
- usb port:** Available as option
- cup holder:** Available as option on the V613 and V614
- foot option # 1:** Stainless Steel Finish
- foot option # 2:** Stainless Steel Bronze Finish

LEATHER COLOR SHADE DIFFERENCES: The model upholstered with some Natural leather such as Maya, Moss, Carees and Sensation, could present in some area differences in color tones of about 5%. Such differences are not to be considered defect but an expression of the natural characteristic of the cowhide. The company reserves the right without prior notice to make technical sheets changes and/or materials for quality product improvement. Leather sofas are a handmade product and according to the leather covering selected there could be a measurement tolerance of about 2 inches (cm 5) on each sku.
REV. 002 DEL 28/10/2020 | Pag. 2 of 2

Vogue

Embellished by several stylish details running along the armrests and enhanced by the welcoming recliner system which is the core comfort of this sofa, Vogue is a new idea of contemporary relaxation.



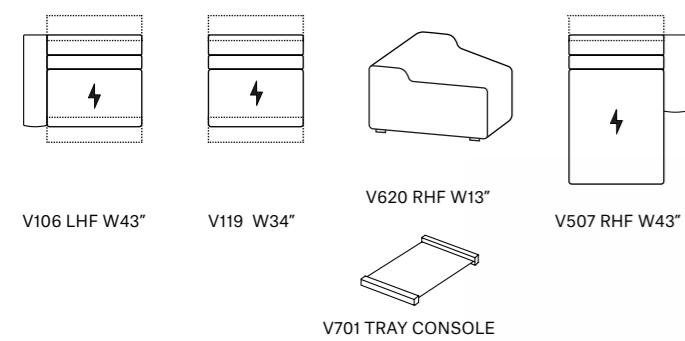

Vogue

Vogue is a unique power motion designed to guarantee a sophisticated elegant look, comfort and relaxation. Vogue is equipped with a state of the art power mechanism and touchpad that individually controls headrest and footrest allowing maximum comfort and support for your head, back and legs even for the tallest people. This model is available with two seat width options and it's modularity allows to make any size sofa or sectional. In addition, the seat and back is composed of memory foam and the extreme soft seating comfort perfectly adapts to the body. The armrest stitching and pipping is very elegant and sophisticated leg inserted in the outside arm gives this model a sartorial look.

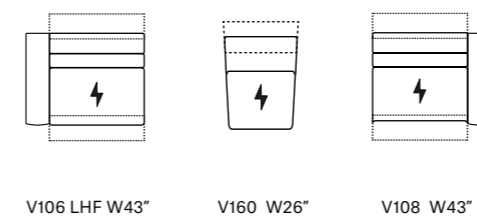
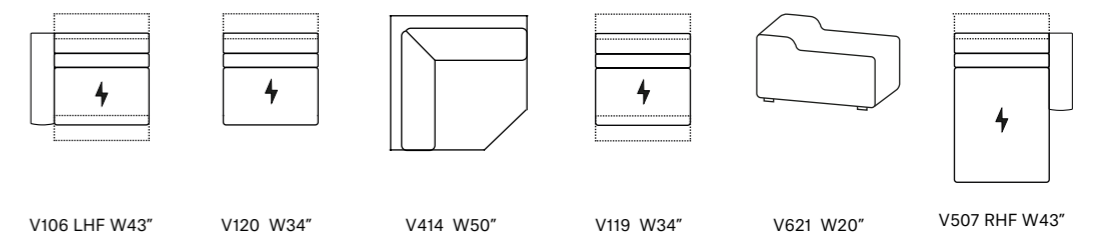

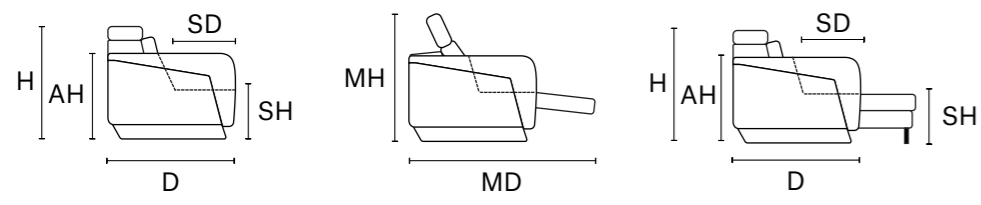

D 44" MD 67" H 33" AH 24" SH 19" SD 23" MH 41"

MAXI SEAT (version of the group have the same seat width)

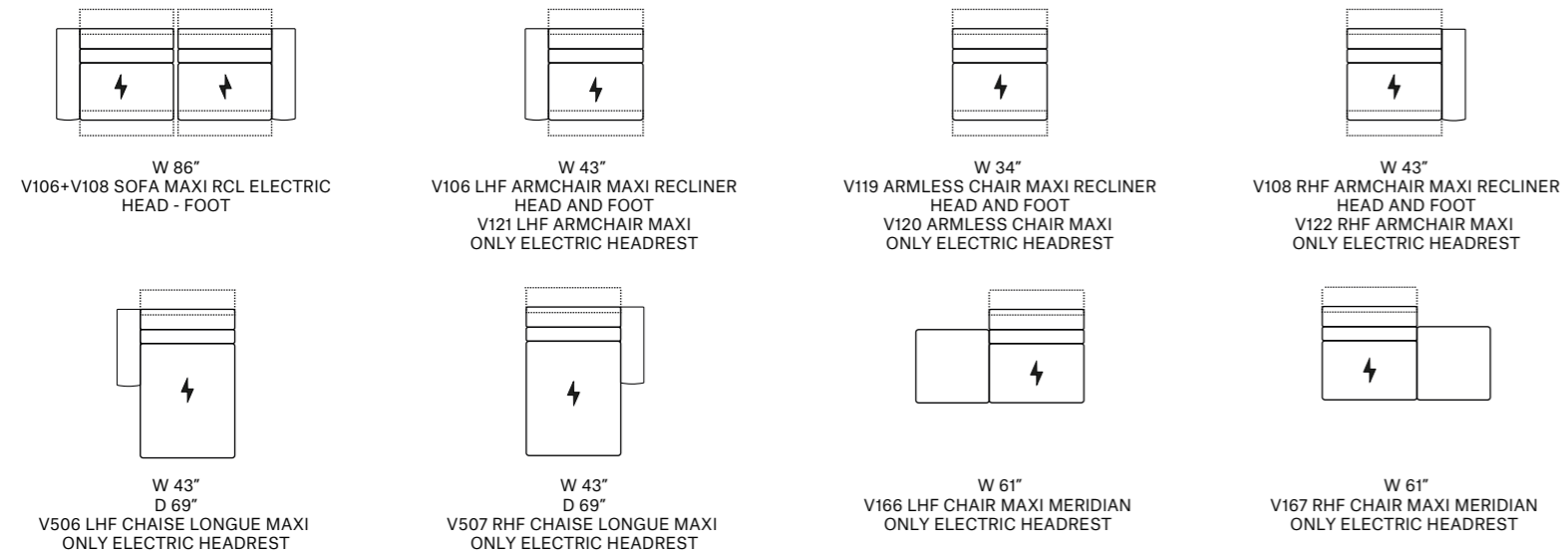

MINI SEAT (version of the group have the same seat width)

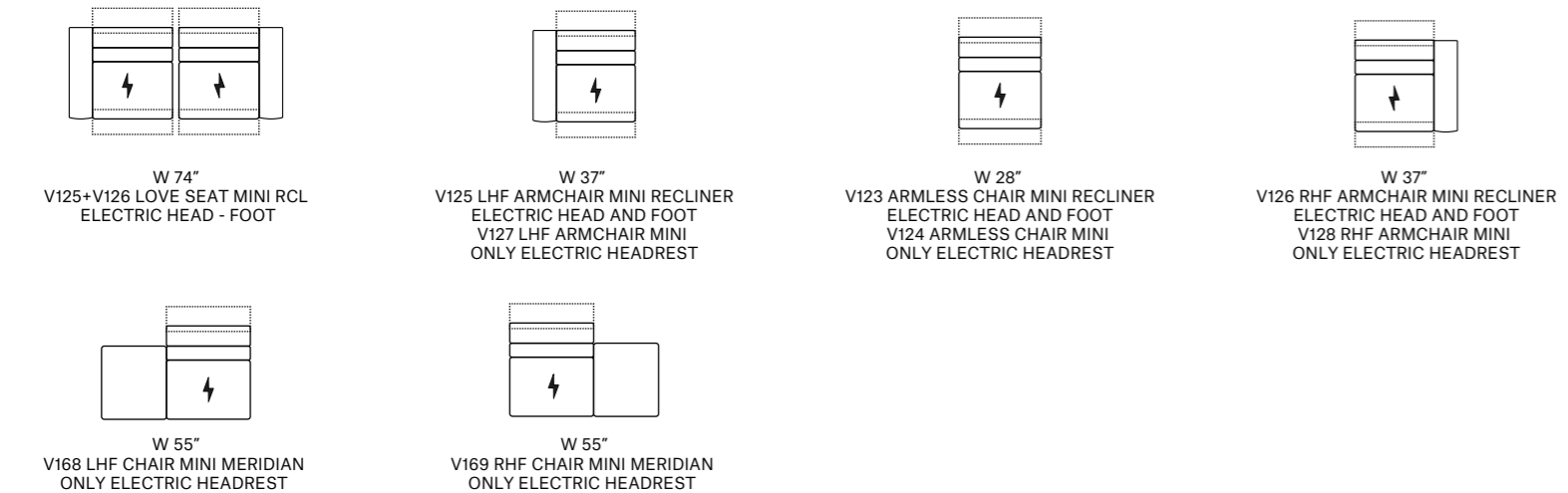

JOLLY (can be combined with all the version group)

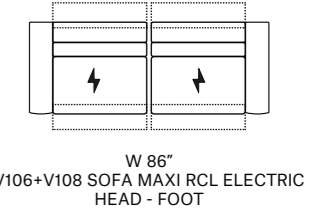
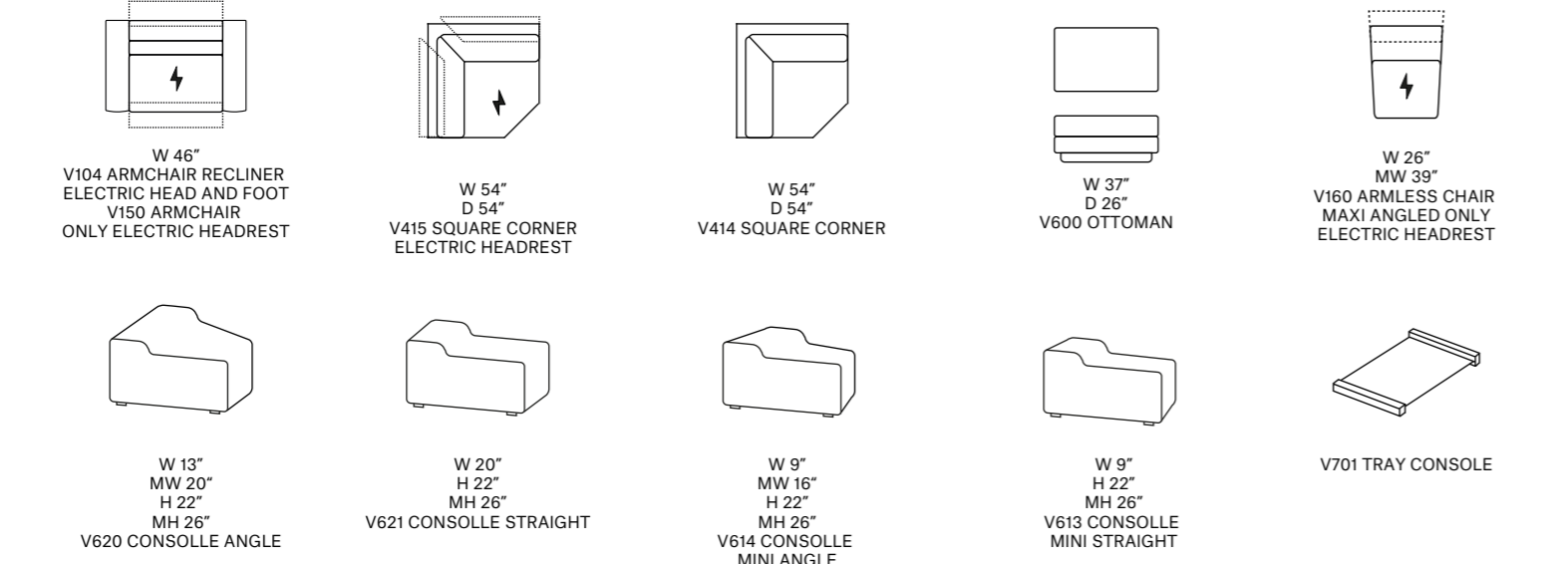

Foot Finishing Option



Foot Option 1:
Stainless Steel Arm Sled



Foot Option 2:
Stainless Steel Bronze Finish Arm Sled



Decor stitch:
Tipe H

Vogue

Technical Description

- decor stitch:** Type "H" available as option
- thick stitch:** Available as option
- structure:** Hardwood frame for extra strength
- seat/back suspension:** Reinforced elastic webbing
- seat/back cushions:** High density ecologic polyurethane foam with coil springs built inside the cushion covered with a layer of memory foam on top
- removability :** Not available
- mechanisms:** Each seat has two separate motors, one for the headrest and one for the footrest
- battery pack:** Available as option
- usb:** Available as option
- foot option 1:** Stainless Steel Arm Sled
- foot option 2:** Stainless Steel Bronze Finish Arm Sled

LEATHER COLOR SHADE DIFFERENCES: The model upholstered with some Natural leather such as Maya, Moss, Carees and Sensation, could present in some area differences in color tones of about 5%. Such differences are not to be considered defect but an expression of the natural characteristic of the cowhide. The company reserves the right without prior notice to make technical sheets changes and/or materials for quality product improvement. Leather sofas are a handmade product and according to the leather covering selected there could be a measurement tolerance of about 2 inches (cm 5) on each sku.
REV. 002 DEL 28/10/2020 | Pag. 2 of 2

Zeus

Welcoming, enveloping, charming. Zeus allows you to adjust the backrests and seats at different heights without ever compromising its unmistakable modern style. A masterpiece for the living room



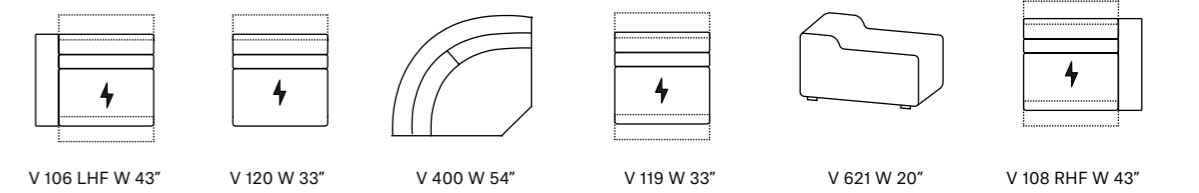
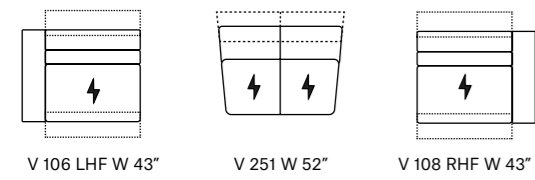

Zeus

Zeus is an elegant modern power motion designed to guarantee a sophisticated elegant look, comfort and relaxation. Zeus is equipped with a state of the art power mechanism and touchpad that individually controls headrest and footrest allowing maximum comfort and support for your head, back and legs even for the tallest people. This model is available with two seat width options and it's modularity allows to make any size sofa or sectional.

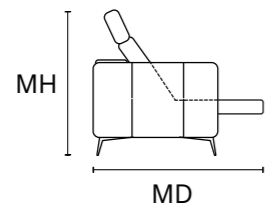
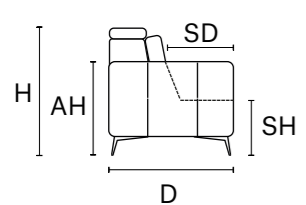

D 44" H 34" SH 19" SD 22" MH 41"

MAXI SEAT (version of the group have the same seat width)

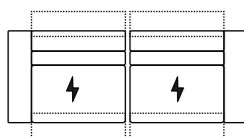

W 86"
V106+V108 SOFA MAXI RCL
ELECTRIC HEAD - FOOT

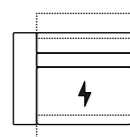

W 43"
V106 LHF ARMCHAIR MAXI RECLINER
ELECTRIC HEAD AND FOOT
V121 LHF ARMCHAIR MAXI
ONLY ELECTRIC HEADREST

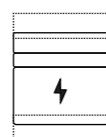

W 33"
V119 ARMLESS CHAIR MAXI RECLINER
ELECTRIC HEAD AND FOOT
V120 ARMLESS CHAIR MAXI
ONLY ELECTRIC HEADREST

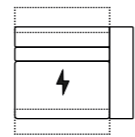

W 43"
V108 RHF ARMCHAIR MAXI RECLINER
ELECTRIC HEAD AND FOOT
V122 RHF ARMCHAIR MAXI
ONLY ELECTRIC HEADREST

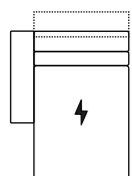

W 43"
D 69"
V506 LHF CHAISE LONGUE MAXI
ONLY ELECTRIC HEADREST

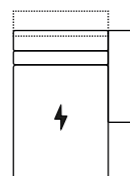

W 43"
D 69"
V507 RHF CHAISE LONGUE MAXI
ONLY ELECTRIC HEADREST

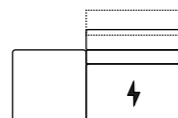

W 61"
V166 LHF CHAIR MAXI MERIDIAN
ONLY ELECTRIC HEADREST

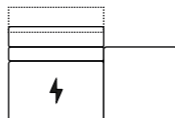

W 61"
V167 RHF CHAIR MAXI MERIDIAN
ONLY ELECTRIC HEADREST

SMALL SEAT (version of the group have the same seat width)

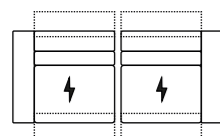

W 74"
V125+V126 LOVE SEAT MAXI RCL
ELECTRIC HEAD - FOOT

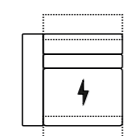

W 37"
V125 LHF ARMCHAIR MINI RECLINER
HEAD AND FOOT
V127 LHF ARMCHAIR MINI
ONLY ELECTRIC HEADREST

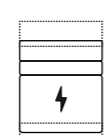

W 28"
V123 ARMLESS CHAIR MINI RECLINER
ELECTRIC HEAD AND FOOT
V124 ARMLESS CHAIR MINI
ONLY ELECTRIC HEADREST

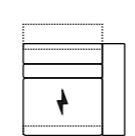

W 37"
V126 RHF ARMCHAIR MINI RECLINER
ELECTRIC HEAD AND FOOT
V128 RHF ARMCHAIR MINI
ONLY ELECTRIC HEADREST

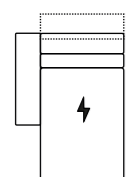

W 37"
D 69"
V508 LHF CHAISE LONGUE MINI
ONLY ELECTRIC HEADREST

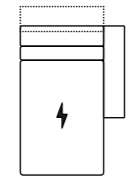

W 37"
D 69"
V509 RHF CHAISE LONGUE MINI
ONLY ELECTRIC HEADREST

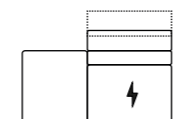

W 56"
V168 LHF CHAIR MINI MERIDIAN
ONLY ELECTRIC HEADREST

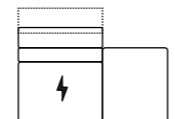

W 56"
V169 RHF CHAIR MINI MERIDIAN
ONLY ELECTRIC HEADREST

JOLLY (can be combined with all the version group)

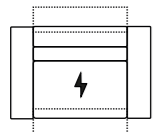

W 47"
V104 ARMCHAIR RECLINER
ELECTRIC HEAD AND FOOT
V150 ARMCHAIR
ONLY ELECTRIC HEADREST



W 54"
D 54"
V400 ROUND CORNER

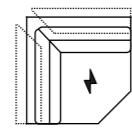

W 54"
D 54"
V415 SQUARE CORNER
ELECTRIC HEADREST

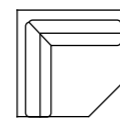

W 54"
D 54"
V414 SQUARE CORNER

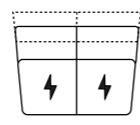

W 52"
MW 65"
V251 LOVESEAT ARMLESS
ANGLED ONLY
ELECTRIC HEADREST



W 26"
MW 39"
V160 ARMLESS CHAIR
MAXI ANGLED
ONLY ELECTRIC HEADREST

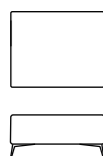

W 35"
D 28"
V600 OTTOMAN

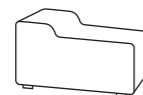

W 9"
H 22"
MH 26"
V613 CONSOLLE MINI STRAIGHT



W 9"
MW 16"
H 22"
MH 26"
V614 CONSOLLE MINI ANGLE

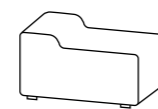

W 20"
H 22"
MH 26"
V621 CONSOLLE STRAIGHT

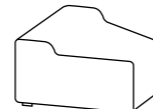

W 13"
H 22"
MW 20"
MH 26"
V620 CONSOLLE ANGLE

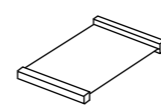

V701 TRAY CONSOLE



Foot Finishing Option



Foot Option 1:
Stainless Steel Finish



Foot Option 2:
Stainless Steel Bronze Finish

Thin stitch standard



Thick stitch option



Zeus

Technical Description

- thick stitch:** Available as option
- structure:** Hardwood frame for extra strenght
- seat/back suspension:** Reinforced elastic webbing
- seat/back cushions:** Hight density ecologic Ecologic open-cell polyurethane foam covered with a layer of dacron wadding.
- removability:** Not possible
- mechanisms:** Each seat has two separate motors, one for the headrest and one for the footrest
- battery pack:** Available as option
- usb:** Available as option
- tray:** Wooden matt black finishing, upon request on consolle
- foot option # 1 :** Stainless Steel Finish
- foot option # 2 :** Stainless Steel Bronze Finish

LEATHER COLOR SHADE DIFFERENCES: The model upholstered with some Natural leather such as Maya, Moss, Carees and Sensation, could present in some area differences in color tones of about 5%. Such differences are not to be considered defect but an expression of the natural characteristic of the cowhide. The company reserves the right without prior notice to make technical sheets changes and/or materials for quality product improvement. Leather sofas are a handmade product and according to the leather covering selected there could be a measurement tolerance of about 2 inches (cm 5) on each sku.
REV. 002 DEL 28/10/2020 | Pag. 2 of 2

SOFA BEDS

A real sofa and a real bed. This is the promise of Bracci sofa beds, which enhance the comfort and design of a sofa with the comfort of a bed, to make the home even more welcoming. A collection in which the aesthetic and functional spheres come together in the most harmonious way possible. Because every day has its own style, and every night its own soft dreams.



Pag. 254
AURELIA



Pag. 270
LUCREZIA



Pag. 258
CORNELIA



Pag. 274
POMPEA



Pag. 262
FLAVIA



Pag. 278
ROMINA



Pag. 266
LIVIA



Pag. 282
VERA

Aurelia

Aurelia does not look like a sofa bed and has an extremely good seating comfort as the seat is filled with the right combination of memory foam. It is built with a state-of-the-art bed mechanism which has wooden slats, then seats and backs are always attached during the opening and closing. The mattress has a 6" thickness and is made in a high-end foam called Waterlilly, which has a high density, is 100% natural, and breathable. Sleeping on this sofa bed is just like sleeping in a regular bed.



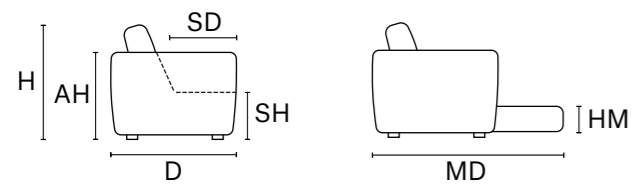

Arms and back are detachable on sofa bed version by just pulling up
D 42" H 35" AH 28" SH 19" SD 22" MD 85" HM 22"

MAXI SEAT (version of the group have the same seat width)

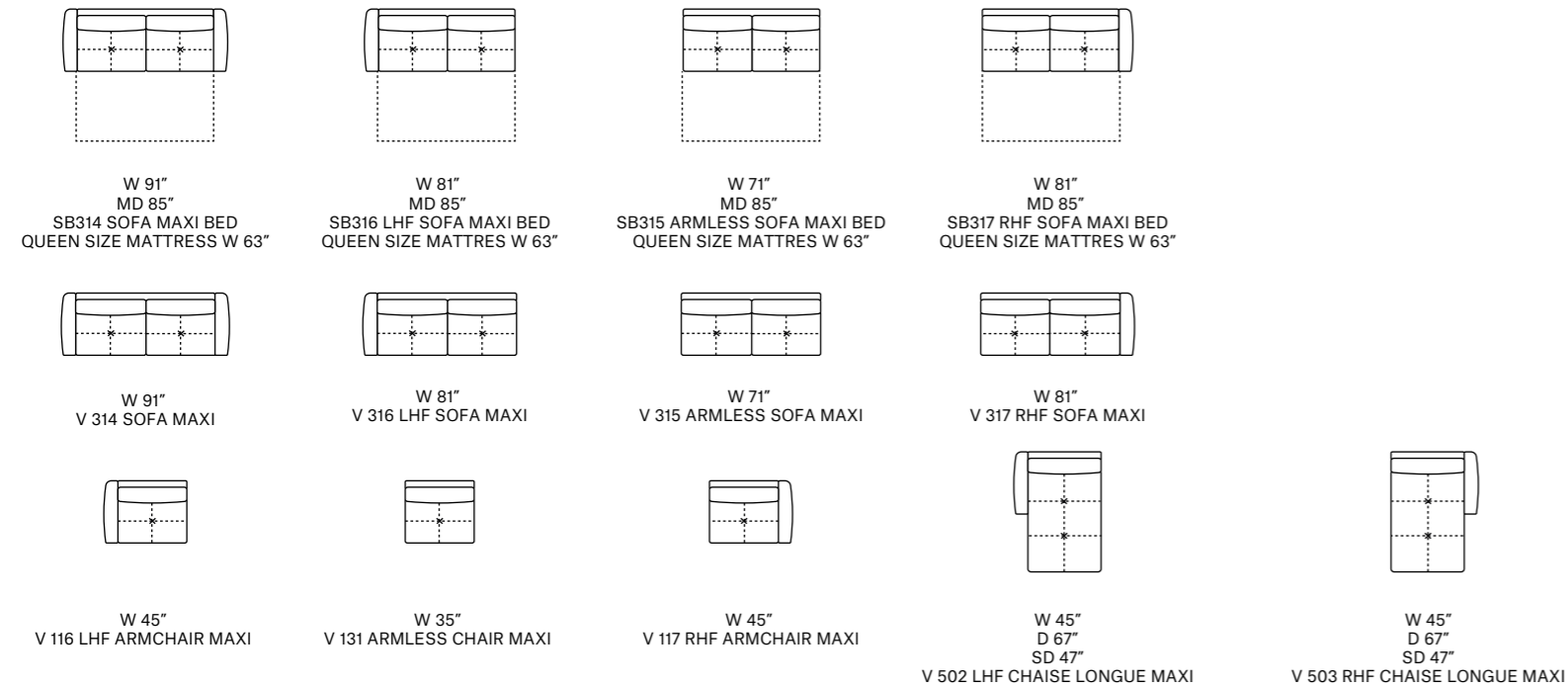

MEDIUM SEAT (version of the group have the same seat width)

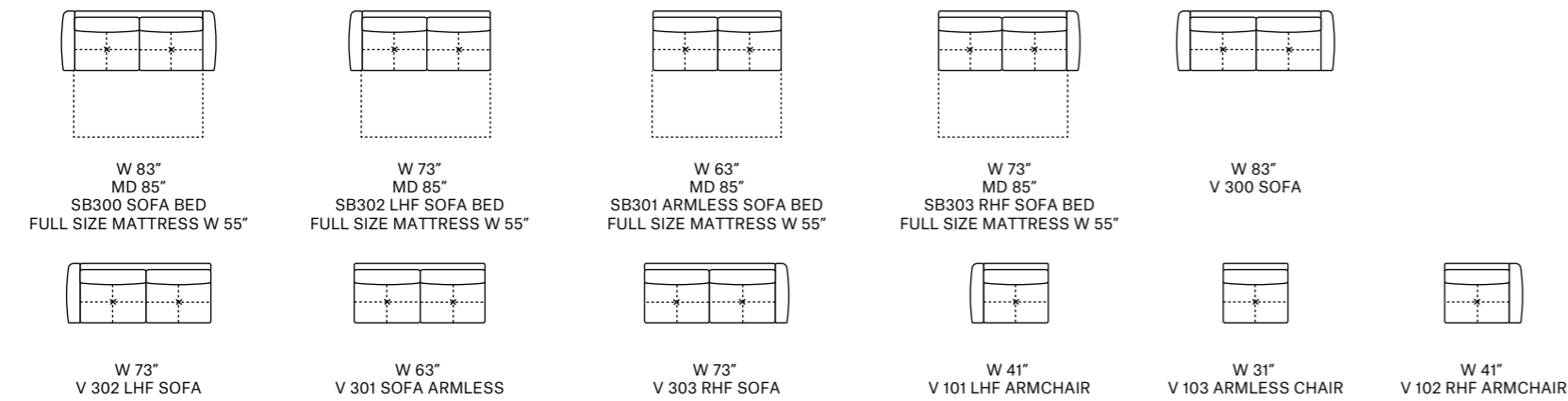

SMALL SEAT (version of the group have the same seat width)

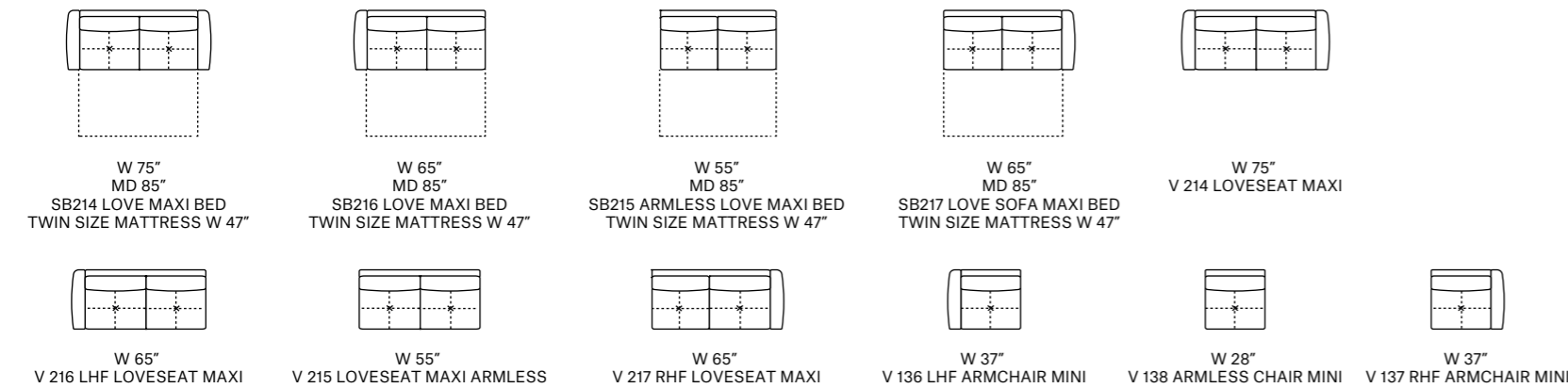

JOLLY (can be combined with all the version group)



Aurelia

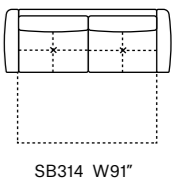

Technical Description

- thick stitch:** Available as an option
- structure:** Synchronized and orthopedic metal bed mechanism. Bed area made with beech wood slats 6,3"wide. Reinforced elastic webbing on the seating area.
- mattress h 6,3" :** Waterlily viscoelastic high density and high resilience foam, covered with a special polyester fiber fire retardant. External quilted layer made in cotton fabric. The Mattress is 100% recyclable, antibacterial, breathable.
- back suspension:** Reinforced elastic webbing
- seat cushions:** High density ecologic open-cell polyurethane foam and memory foam, covered with a layer of dacron wadding
- back cushions:** High density ecologic open-cell polyurethane foam, covered with a layer of dacron wadding
- removability:** Seat and Back cushion removability is not available for the sofa bed version. Removability is only available on version without bed
- foot option 1:** Stainless steel Finish
- foot option 2:** Stainless steel Bronze Finish

Foot Finishing Option



- Foot Option 1:** Stainless steel Finish
- Foot Option 2:** Stainless steel Bronze Finish

Thin stitch standard Thick stitch option



LEATHER COLOR SHADE DIFFERENCES: The model upholstered with some Natural leather such as Maya, Moss, Carees and Sensation, could present in some area differences in color tones of about 5%. Such differences are not to be considered defect but an expression of the natural characteristic of the cowhide. The company reserves the right without prior notice to make technical sheets changes and/or materials for quality product improvement. Leather sofas are a handmade product and according to the leather covering selected there could be a measurement tolerance of about 2 inches (cm 5) on each sku.
 REV. 002 DEL 28/10/2020 | Pag. 2 of 2

Cornelia

Cornelia does not look like a sofa bed and has an extremely good seating comfort as the seat is filled with the right combination of memory foam. It is built with a state-of-the-art bed mechanism which has wooden slats, then seats and backs are always attached during the opening and closing. The mattress has a 6" thickness and is made in a high-end foam called Waterlilly, which has a high density, is 100% natural, and breathable. Sleeping on this sofa bed is just like sleeping in a regular bed.



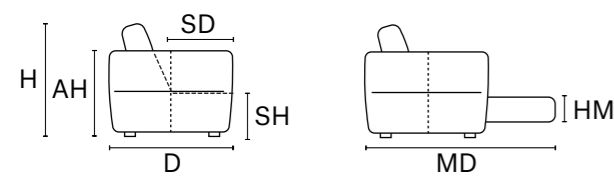

Arms and back are detachable on sofa bed version by just pulling up
D 42" H 35" AH 28" SH 19" SD 22" MD 85" HM 22"

MAXI SEAT (version of the group have the same seat width)

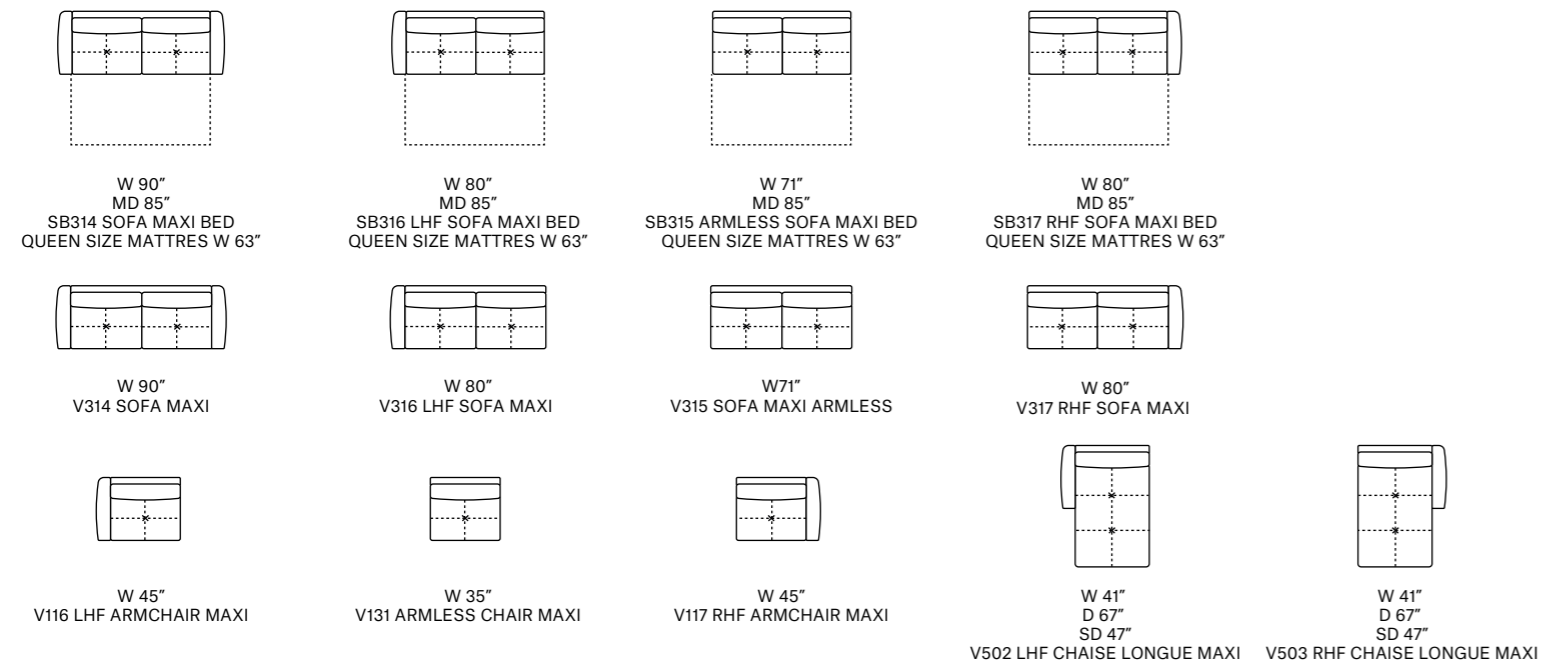

MEDIUM SEAT (version of the group have the same seat width)

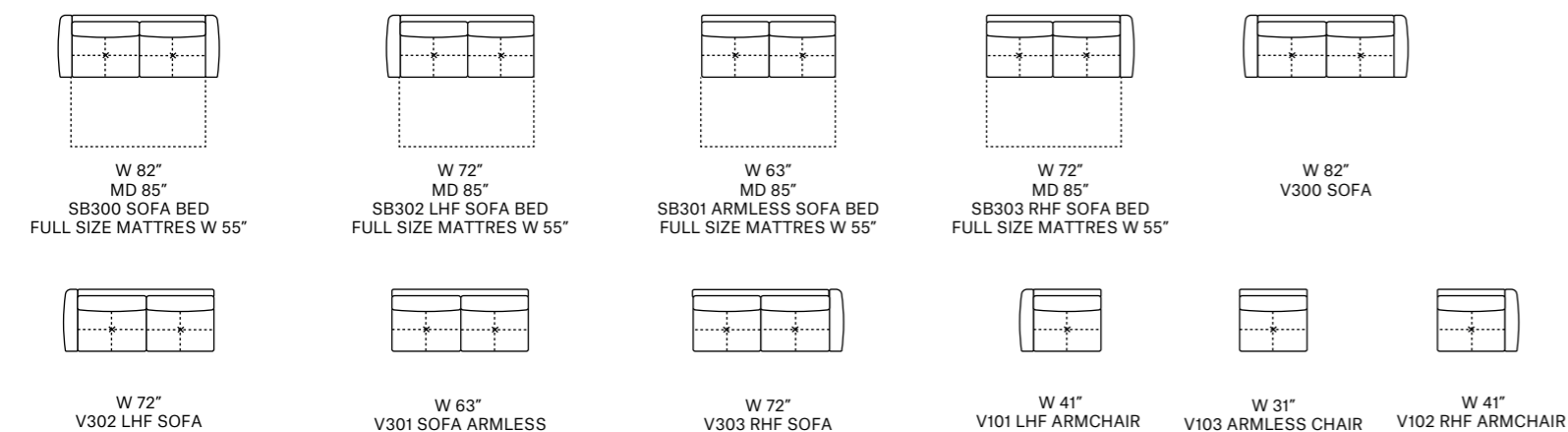

SMALL SEAT (version of the group have the same seat width)

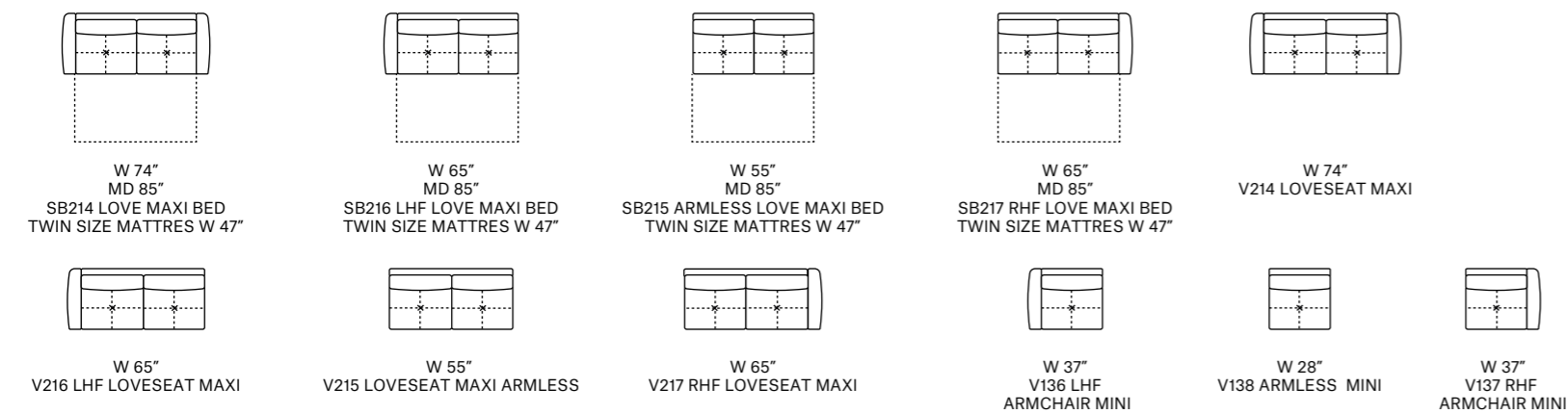

JOLLY (can be combined with all the version group)

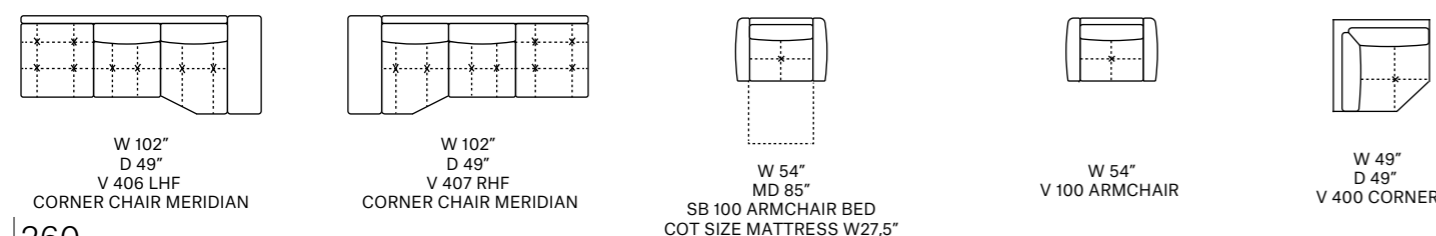

Cornelia

Technical Description

thick stitch: Available as an option
structure: Synchronized and orthopedic metal bed mechanism. Bed area made with beech wood slats 6,3"wide. Reinforced elastic webbing on the seating area.
mattress h 6,3": Waterlily viscoelastic high density and high resilience foam, covered with a special polyester fiber fire retardant. External quilted layer made in cotton fabric. The Mattress is 100% recyclable, antibacterial, breathable.
back suspension: Reinforced elastic webbing
seat cushions: High density ecologic open-cell polyurethane foam and memory foam, covered with a layer of dacron wadding
back cushions: High density ecologic open-cell polyurethane foam, covered with a layer of dacron wadding
removability: Seat and Back cushion removability is not available for the sofa bed version.
 Removability is only available on version without bed
foot option 1: Stainless Steel Finish
foot option 2: Stainless Steel Bronze Finish

Foot Finishing Option

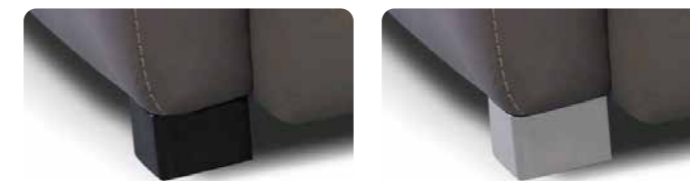

Foot Option 1:
Stainless Steel Finish

Foot Option 2:
Stainless Steel Bronze Finish

Thin stitch standard



Thick stitch option

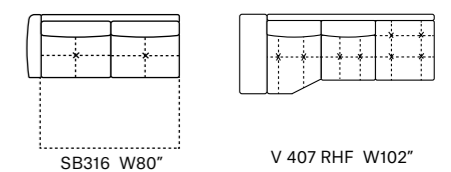

LEATHER COLOR SHADE DIFFERENCES: The model upholstered with some Natural leather such as Maya, Moss, Carees and Sensation, could present in some area differences in color tones of about 5%. Such differences are not to be considered defect but an expression of the natural characteristic of the cowhide. The company reserves the right without prior notice to make technical sheets changes and/or materials for quality product improvement. Leather sofas are a handmade product and according to the leather covering selected there could be a measurement tolerance of about 2 inches (cm 5) on each sku.

Flavia

Flavia does not look like a sofa bed and has an extremely good seating comfort as the seat is filled with the right combination of memory foam. It is built with a state-of-the-art bed mechanism which has wooden slats, then seats and backs are always attached during the opening and closing. The mattress has a 6" thickness and is made in a high-end foam called Waterlilly, which has a high density, is 100% natural, and breathable. Sleeping on this sofa bed is just like sleeping in a regular bed.



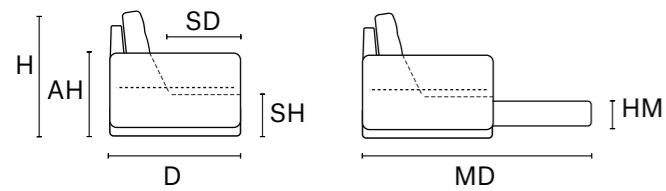

Arms and back are detachable on sofa bed version by just pulling up
D 41" H 38" AH 26" SH 19" SD 22" MD 85" HM 22"

MAXI SEAT (version of the group have the same seat width)

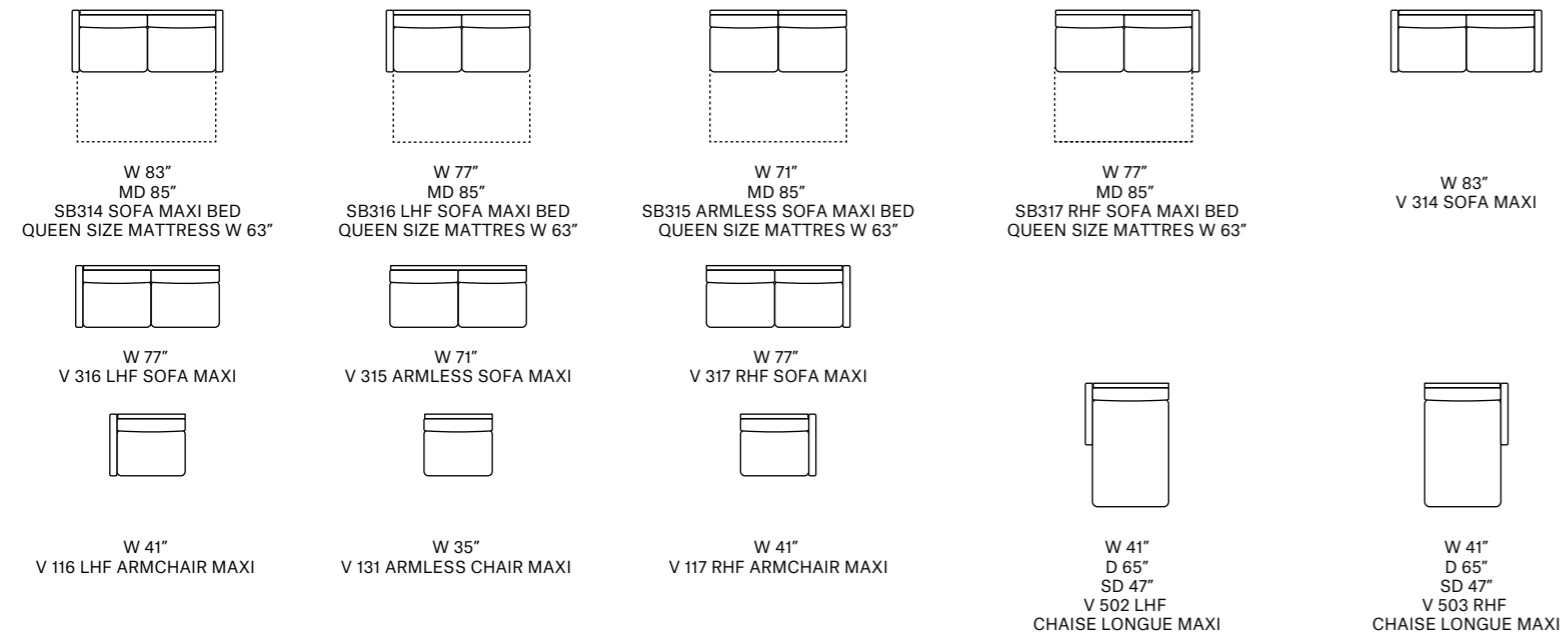

MEDIUM SEAT (version of the group have the same seat width)

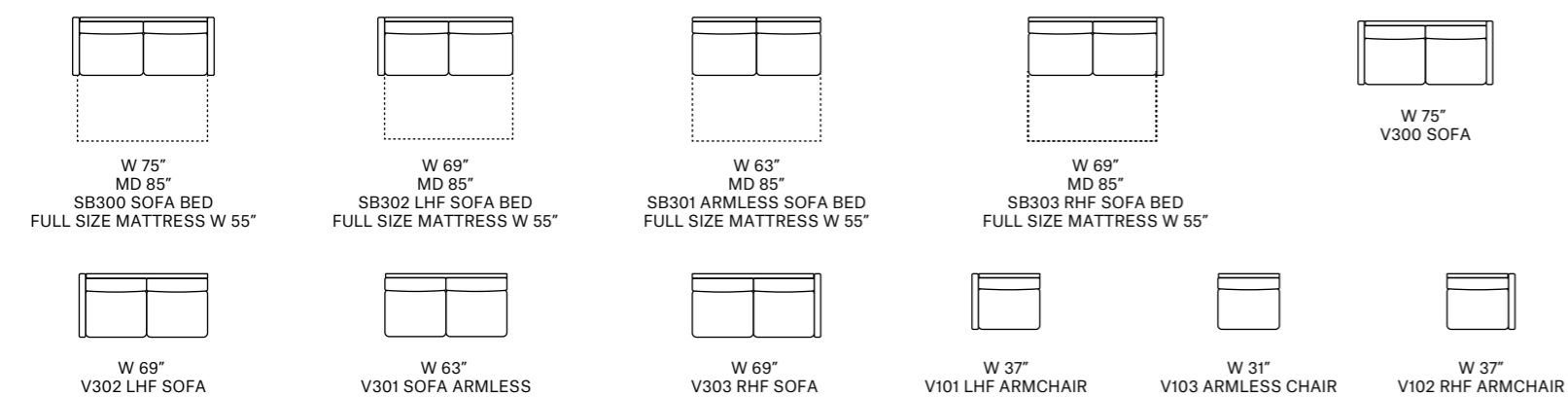

SMALL SEAT (version of the group have the same seat width)

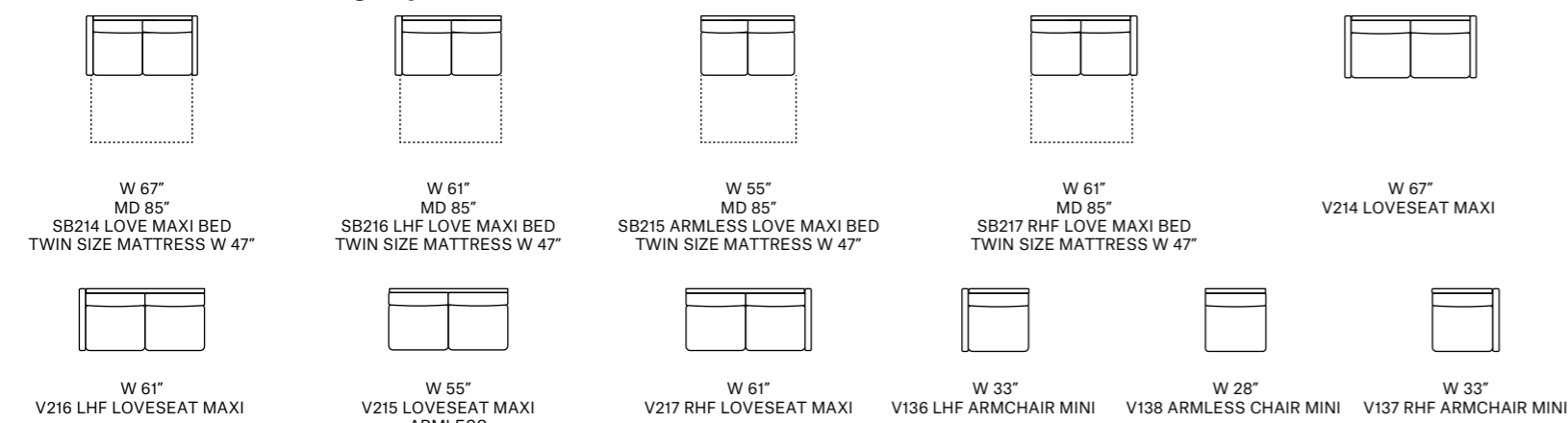

JOLLY (can be combined with all the version group)



Flavia

Technical Description

thick stitch: Available as an option
structure: Synchronized and orthopedic metal bed mechanism. Bed area made with beech wood slats 6,3"wide. Reinforced elastic webbing on the seating area.
mattress h 6,3": Waterlily viscoelastic high density and high resilience foam, covered with a special polyester fiber fire retardant. External quilted layer made in cotton fabric. The Mattress is 100% recyclable, anti bacterial, breathable.
back suspension: Reinforced elastic webbing
seat cushions: High density ecologic open-cell polyurethane foam and memory foam, covered with a layer of dacron wadding
back cushions: High density ecologic open-cell polyurethane foam, covered with a layer of dacron wadding
removability: Seat and Back cushion removability is not available for the sofa bed version.
 Removability is only available on version without bed
foot option 1: Stainless Steel Slead Finish
foot option 2: Stainless Steel Slead Bronze Finish

Foot Finishing Option



Foot Option 1:
Stainless Steel Slead Finish

Foot Option 2:
Stainless Steel Slead Bronze Finish

Thin stitch standard



Thick stitch option

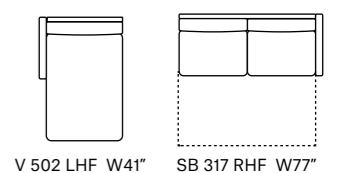

LEATHER COLOR SHADE DIFFERENCES: The model upholstered with some Natural leather such as Maya, Moss, Carees and Sensation, could present in some area differences in color tones of about 5%. Such differences are not to be considered defect but an expression of the natural characteristic of the cowhide. The company reserves the right without prior notice to make technical sheets changes and/or materials for quality product improvement. Leather sofas are a handmade product and according to the leather covering selected there could be a measurement tolerance of about 2 inches (cm 5) on each sku.
 REV. 002 DEL 28/10/2020 | Pag. 2 of 2

Livia

Livia does not look like a sofa bed and has an extremely good seating comfort as the seat is filled with the right combination of memory foam. It is built with a state-of-the-art bed mechanism which has wooden slats, then seats and backs are always attached during the opening and closing. The mattress has a 6" thickness and is made in a high-end foam called Waterlilly, which has a high density, is 100% natural, and breathable. Sleeping on this sofa bed is just like sleeping in a regular bed.



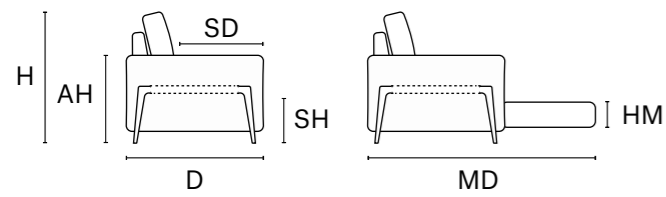

Arms and back are detachable on sofa bed version by just pulling up
D 41" H 38" AH 26" SH 19" SD 22" MD 85" HM 22"

MAXI SEAT (version of the group have the same seat width)

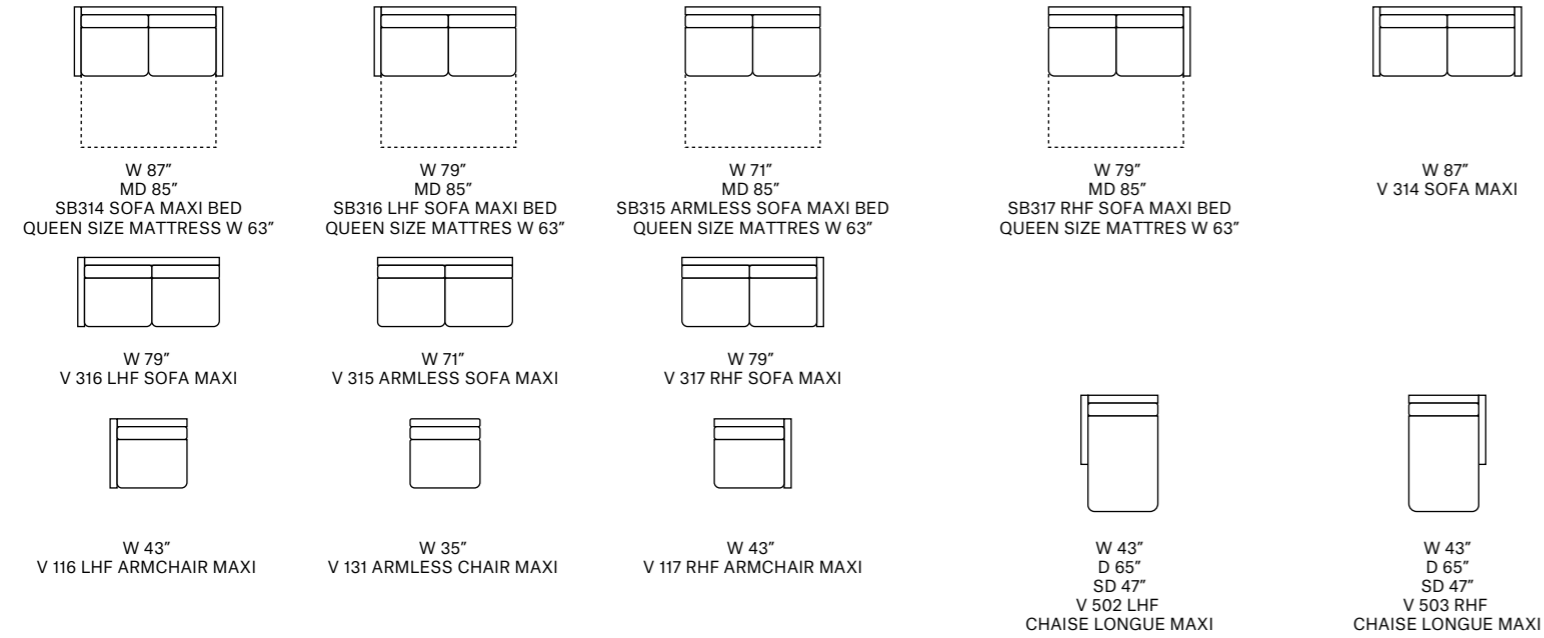

MEDIUM SEAT (version of the group have the same seat width)

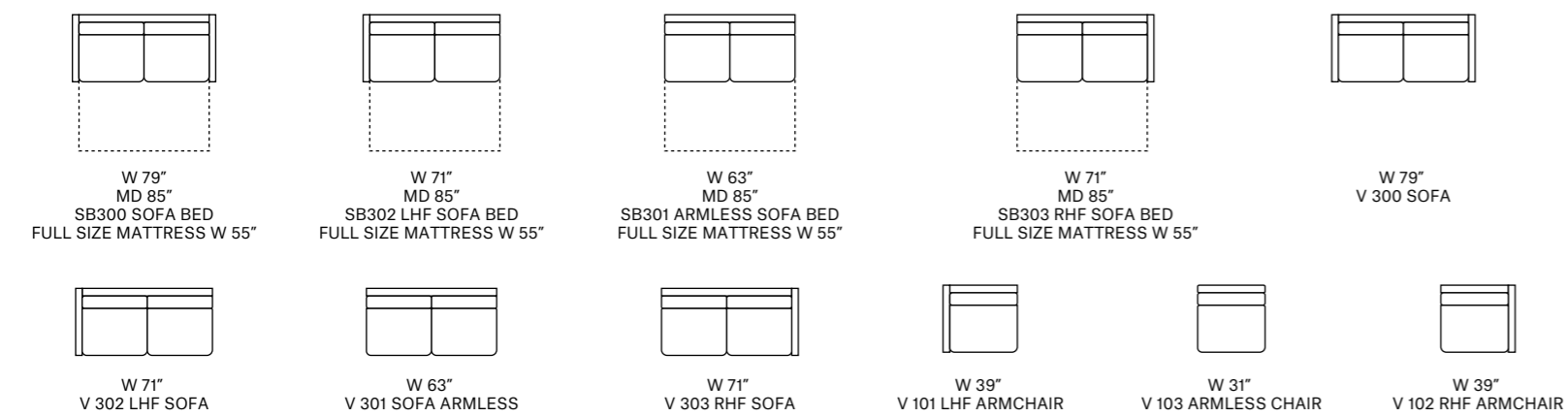

SMALL SEAT (version of the group have the same seat width)

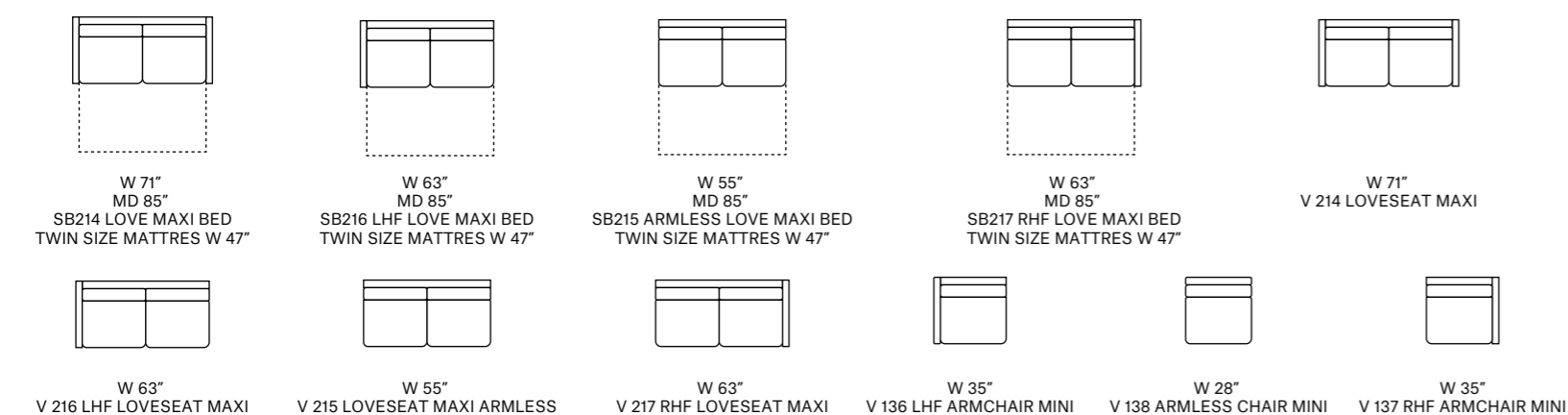

JOLLY (can be combined with all the version group)

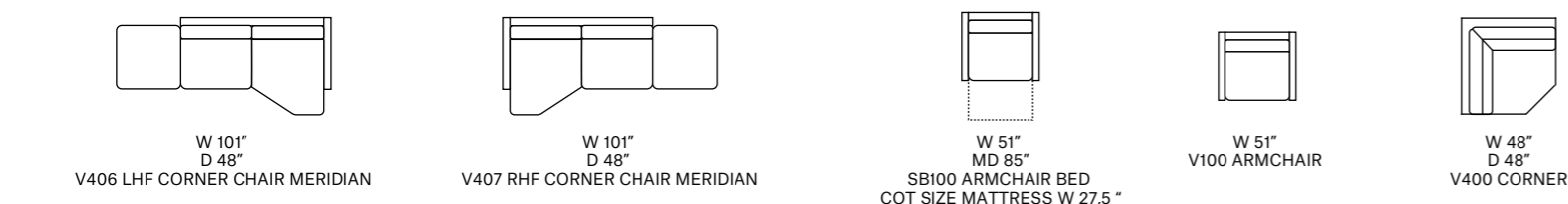

Livia

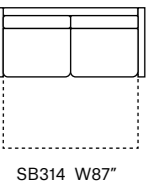

Technical Description

thick stitch: Available as an option
structure: Synchronized and orthopedic metal bed mechanism. Bed area made with beech wood slats 6,3"wide. Reinforced elastic webbing on the seating area.
mattress h 6,3": Waterlily viscoelastic high density and high resilience foam, covered with a special polyester fiber fire retardant. External quilted layer made in cotton fabric. The Mattress is 100% recyclable, antibacterial, breathable.
back suspension: Reinforced elastic webbing
seat cushions: High density ecologic open-cell polyurethane foam and memory foam, covered with a layer of dacron wadding
back cushions: High density ecologic open-cell polyurethane foam, covered with a layer of dacron wadding
removability: Seat and Back cushion removability is not available for the sofa bed version. Removability is only available on version without bed
foot option 1: Stainless Steel Arm Leg
foot option 2: Stainless Steel Arm Leg Bronze Finish

Foot Finishing Option



Foot Option 1:
Stainless Steel Arm Leg

Foot Option 2:
Stainless Steel Arm Leg Bronze Finish

Thin stitch standard



Thick stitch option



LEATHER COLOR SHADE DIFFERENCES: The model upholstered with some Natural leather such as Maya, Moss, Carees and Sensation, could present in some area differences in color tones of about 5%. Such differences are not to be considered defect but an expression of the natural characteristic of the cowhide. The company reserves the right without prior notice to make technical sheets changes and/or materials for quality product improvement. Leather sofas are a handmade product and according to the leather covering selected there could be a measurement tolerance of about 2 inches (cm 5) on each sku.
 REV. 002 DEL 28/10/2020 | Pag. 2 of 2

Lucrezia

Lucrezia does not look like a sofa bed and has an extremely good seating comfort as the seat is filled with the right combination of memory foam. It is built with a state-of-the-art bed mechanism which has wooden slats, then seats and backs are always attached during the opening and closing. The mattress has a 6" thickness and is made in a high-end foam called Waterlilly, which has a high density, is 100% natural, and breathable. Sleeping on this sofa bed is just like sleeping in a regular bed.



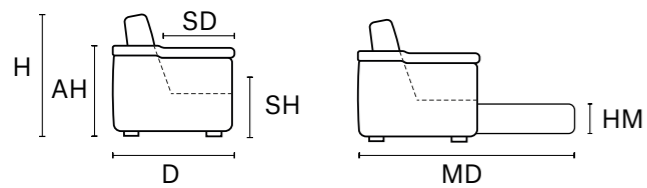

Arms and back are detachable on sofa bed version by just pulling up

D 42" H 35" AH 28" SH 19" SD 22" MD 85" HM 22"

MAXI SEAT (version of the group have the same seat width)

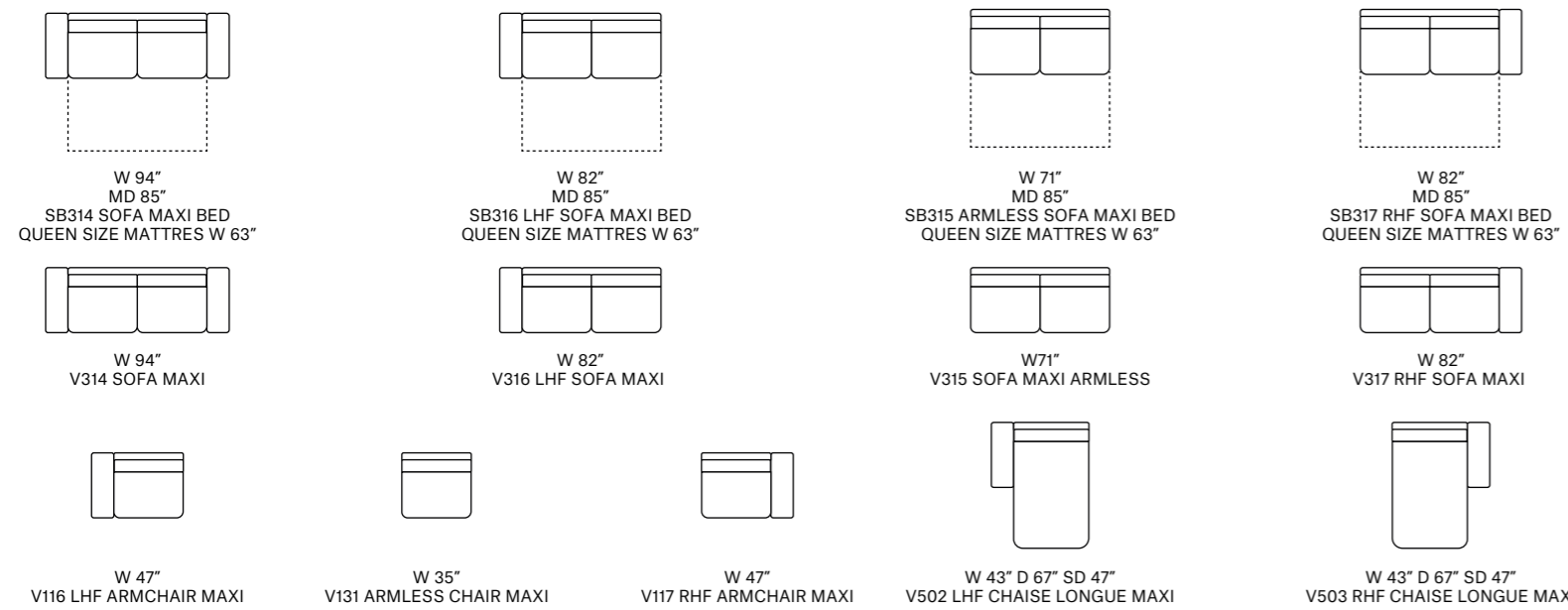

MEDIUM SEAT (version of the group have the same seat width)

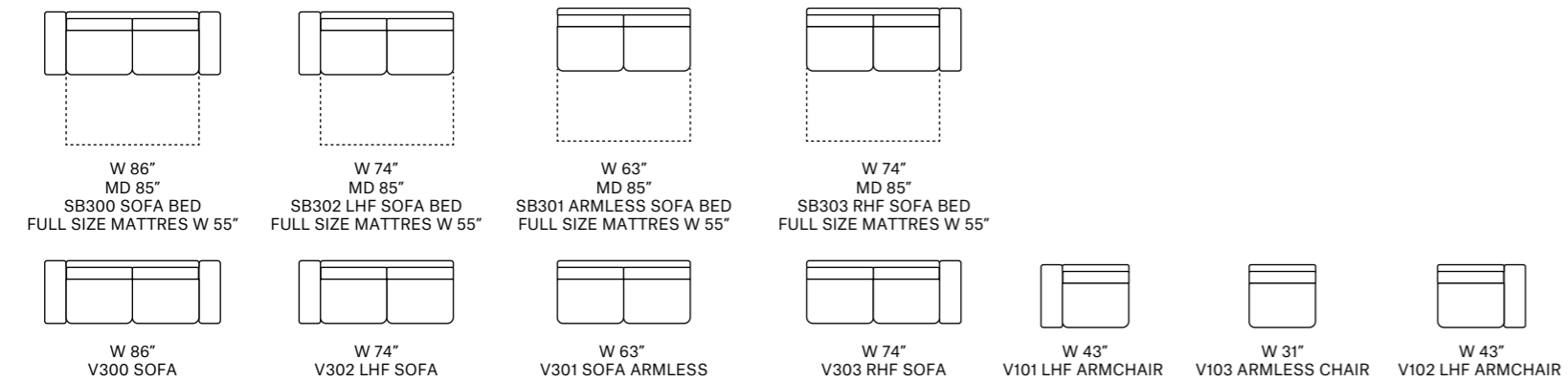

SMALL SEAT (version of the group have the same seat width)

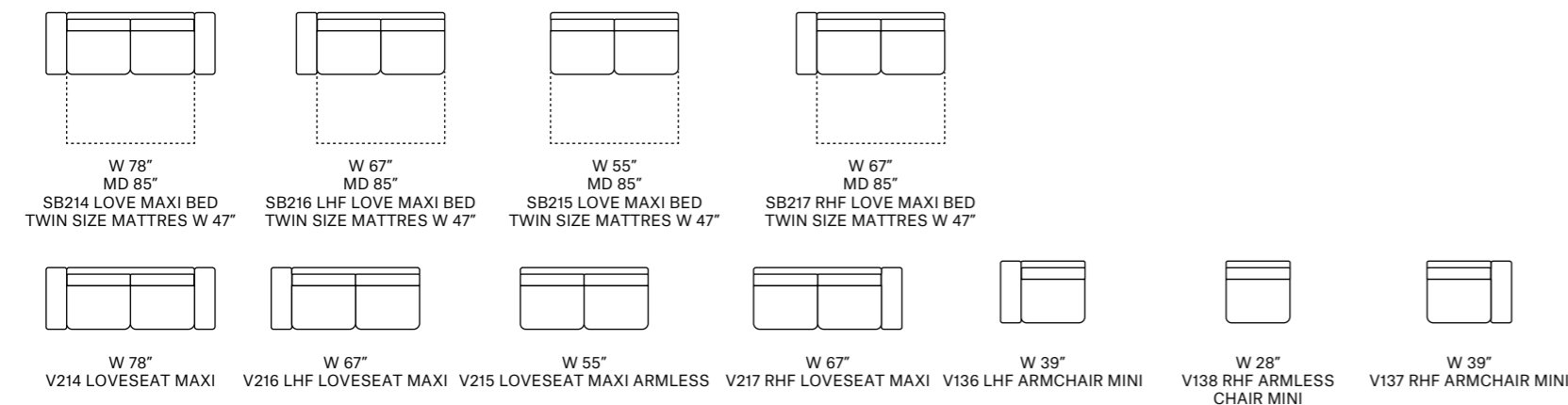

JOLLY (can be combined with all the version group)

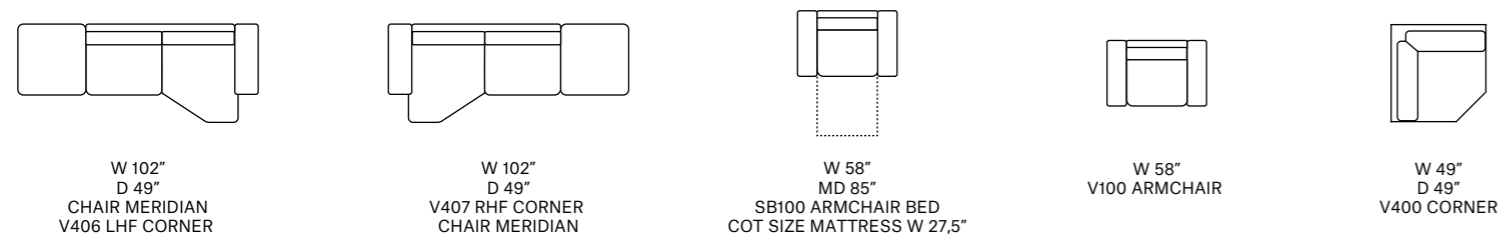

Lucrezia

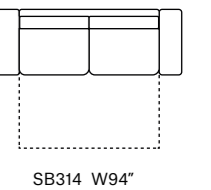

Technical Description

- thick stitch:** Available as an option
- structure:** Synchronized and orthopedic metal bed mechanism. Bed area made with beech wood slats 6,3"wide. Reinforced elastic webbing on the seating area.
- mattress h 6,3":** Waterlily viscoelastic high density and high resilience foam, covered with a special polyester fiber fire retardant. External quilted layer made in cotton fabric. The Mattress is 100% recyclable, antibacterial, breathable.
- back suspension:** Reinforced elastic webbing
- seat cushions:** High density ecologic open-cell polyurethane foam and memory foam, covered with a layer of dacron wadding
- back cushions:** High density ecologic open-cell polyurethane foam, covered with a layer of dacron wadding
- removability:** Seat and Back cushion removability is not available for the sofa bed version. Removability is only available on version without bed
- foot option 1:** Stainless Steel Finish
- foot option 2:** Stainless Steel Bronze Finish

Foot Finishing Option

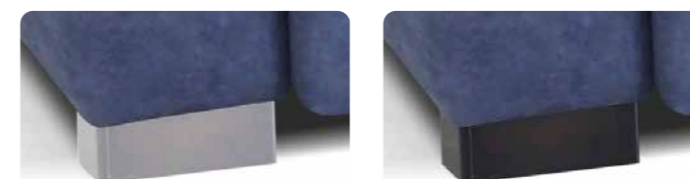

Foot Option 1:
Stainless Steel Finish

Foot Option 2:
Stainless Steel Bronze Finish

Thin stitch standard



Thick stitch option



LEATHER COLOR SHADE DIFFERENCES: The model upholstered with some Natural leather such as Maya, Moss, Carees and Sensation, could present in some area differences in color tones of about 5%. Such differences are not to be considered defect but an expression of the natural characteristic of the cowhide. The company reserves the right without prior notice to make technical sheets changes and/or materials for quality product improvement. Leather sofas are a handmade product and according to the leather covering selected there could be a measurement tolerance of about 2 inches (cm 5) on each sku.
REV. 002 DEL 28/10/2020 | Pag. 2 of 2

Pompea

Pompea does not look like a sofa bed and has an extremely good seating comfort as the seat is filled with the right combination of memory foam. It is built with a state-of-the-art bed mechanism which has wooden slats, then seats and backs are always attached during the opening and closing. The mattress has a 6" thickness and is made in a high-end foam called Waterlilly, which has a high density, is 100% natural, and breathable. Sleeping on this sofa bed is just like sleeping in a regular bed.



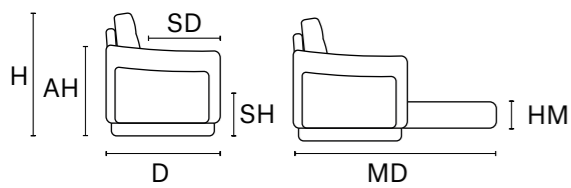

Arms and back are detachable on sofa bed version by just pulling up

D 41" H 38" AH 26" SH 19" SD 22" MD 85" HM 22"

MAXI SEAT (version of the group have the same seat width)

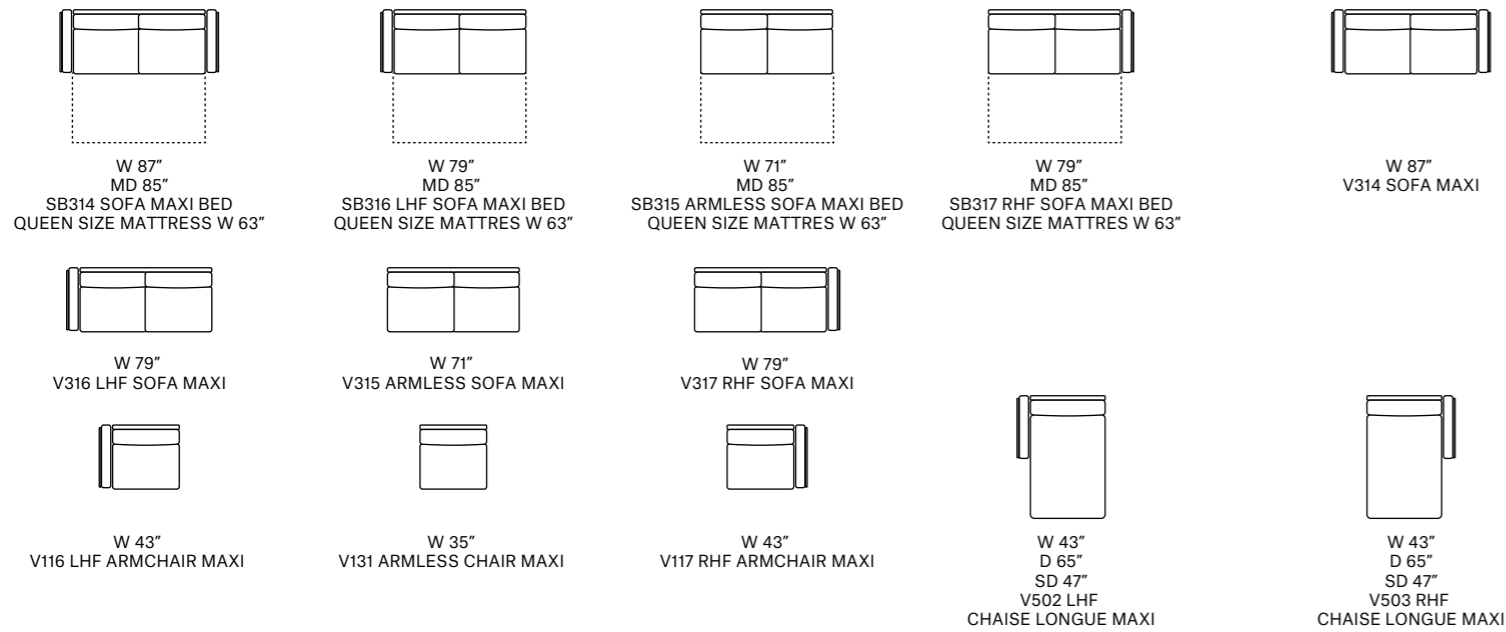

MEDIUM SEAT (version of the group have the same seat width)

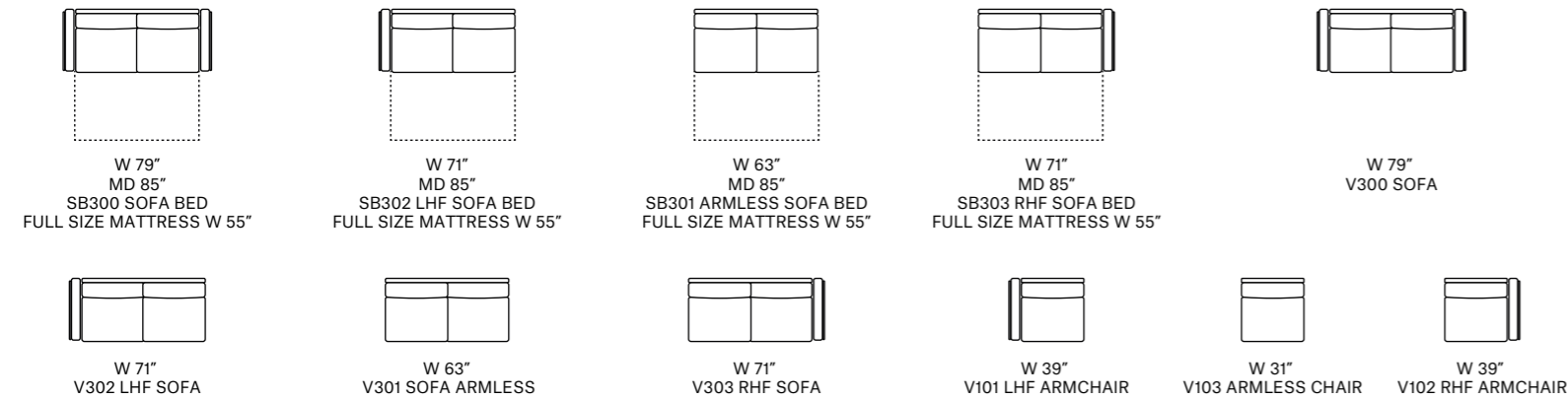

SMALL SEAT (version of the group have the same seat width)

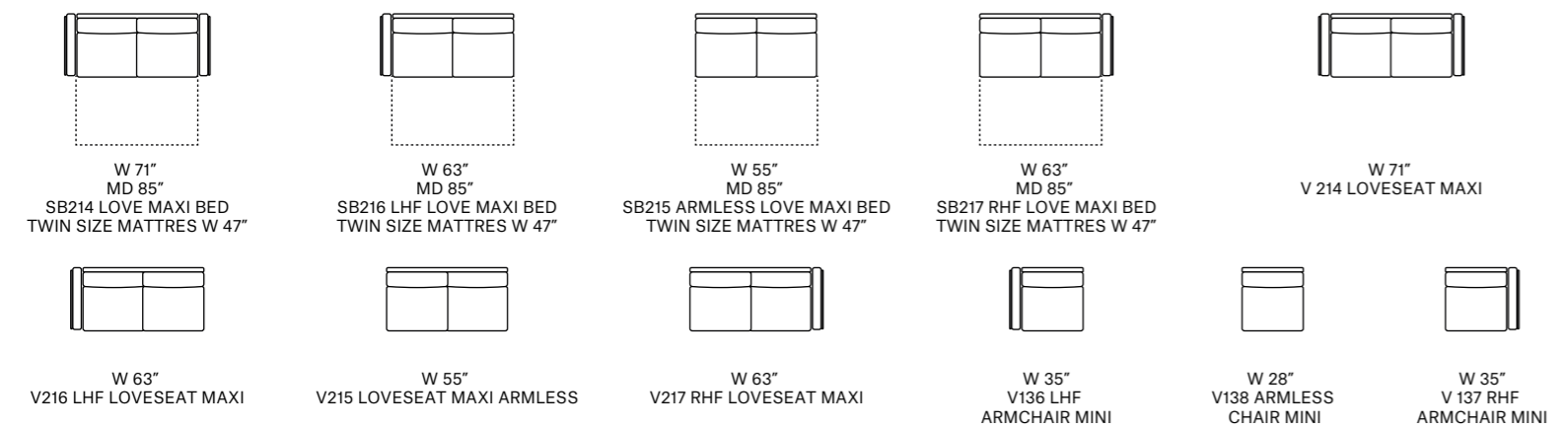

JOLLY (can be combined with all the version group)

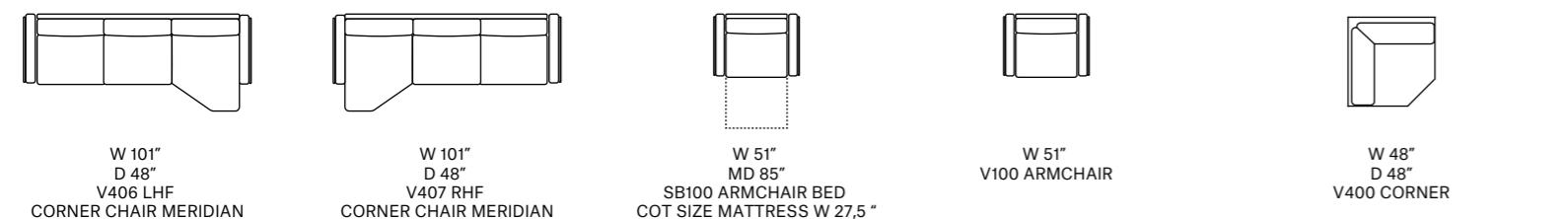

Pompea

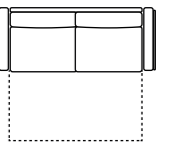

SB314 W87"

Technical Description

thick stitch: Available as an option
structure: Synchronized and orthopedic metal bed mechanism. Bed area made with beech wood slats 6,3"wide. Reinforced elastic webbing on the seating area.
mattress h 6,3" : Waterlily viscoelastic high density and high resilience foam, covered with a special polyester fiber fire retardant. External quilted layer made in cotton fabric. The Mattress is 100% recyclable, antibacterial, breathable.
back suspension: Reinforced elastic webbing
seat cushions: High density ecologic open-cell polyurethane foam and memory foam, covered with a layer of dacron wadding
back cushions: High density ecologic open-cell polyurethane foam, covered with a layer of dacron wadding
removability: Seat and Back cushion removability is not available for the sofa bed version. Removability is only available on version without bed
foot option 1: Stainless steel Arm Sled Finish
foot option 2: Stainless steel Arm Sled Bronze Finish

Foot Finishing Option



Foot Option 1: Stainless steel Arm Sled Finish
Foot Option 2: Stainless steel Arm Sled Bronze Finish

LEATHER COLOR SHADE DIFFERENCES: The model upholstered with some Natural leather such as Maya, Moss, Carees and Sensation, could present in some area differences in color tones of about 5%. Such differences are not to be considered defect but an expression of the natural characteristic of the cowhide. The company reserves the right without prior notice to make technical sheets changes and/or materials for quality product improvement. Leather sofas are a handmade product and according to the leather covering selected there could be a measurement tolerance of about 2 inches (cm 5) on each sku.
 REV. 002 DEL 28/10/2020 | Pag. 2 of 2



Romina

Romina does not look like a sofa bed and has an extremely good seating comfort as the seat is filled with the right combination of memory foam. It is built with a state-of-the-art bed mechanism which has wooden slats, then seats and backs are always attached during the opening and closing. The mattress has a 6" thickness and is made in a high-end foam called Waterlilly, which has a high density, is 100% natural, and breathable. Sleeping on this sofa bed is just like sleeping in a regular bed.

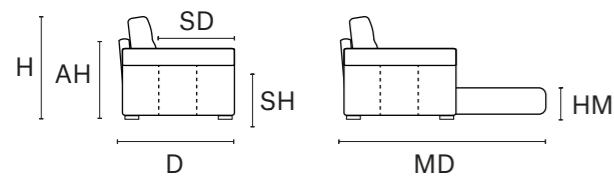

Arms and back are detachable on sofa bed version by just pulling up

D 42" H 35" AH 28" SH 19" SD 22" MD 86" HM 22"

MAXI SEAT (version of the group have the same seat width)

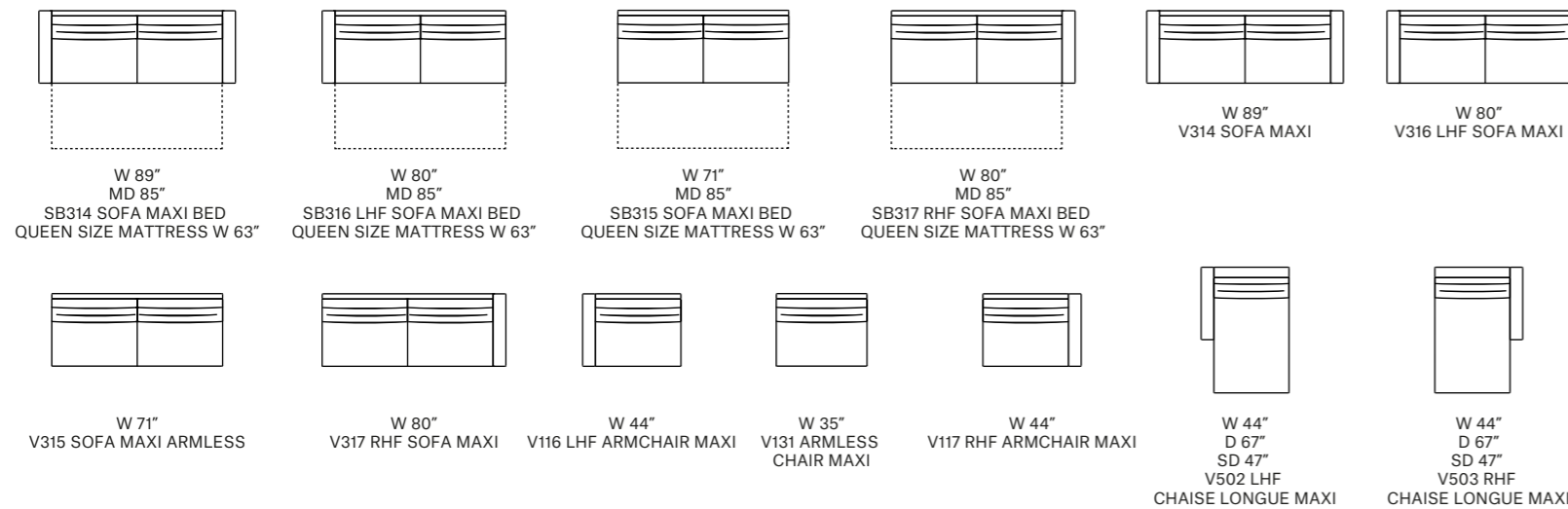

MEDIUM SEAT (version of the group have the same seat width)

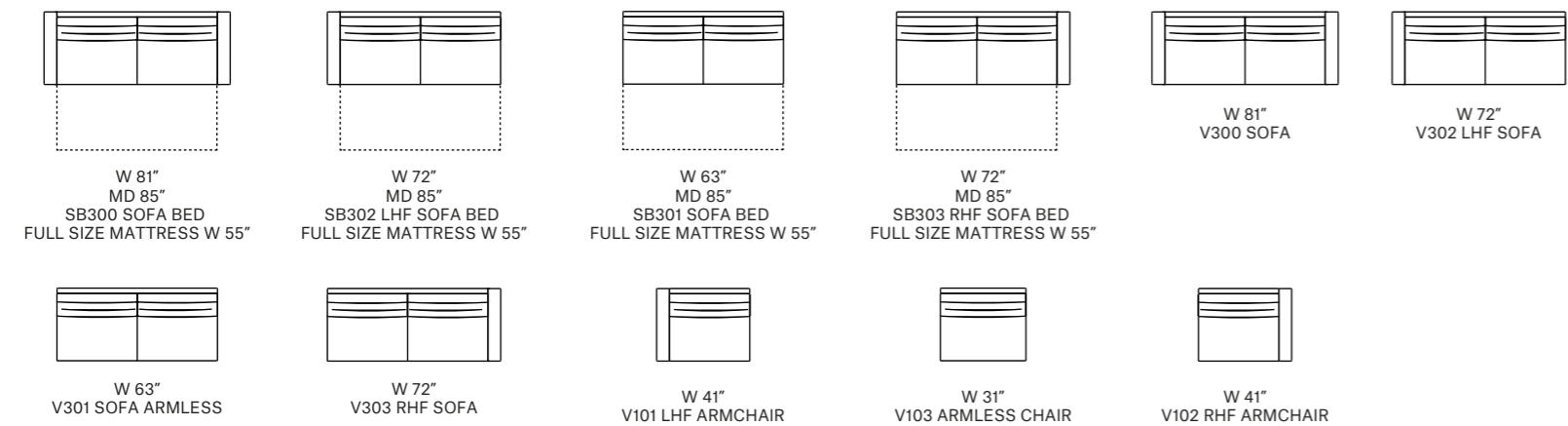

SMALL SEAT (version of the group have the same seat width)

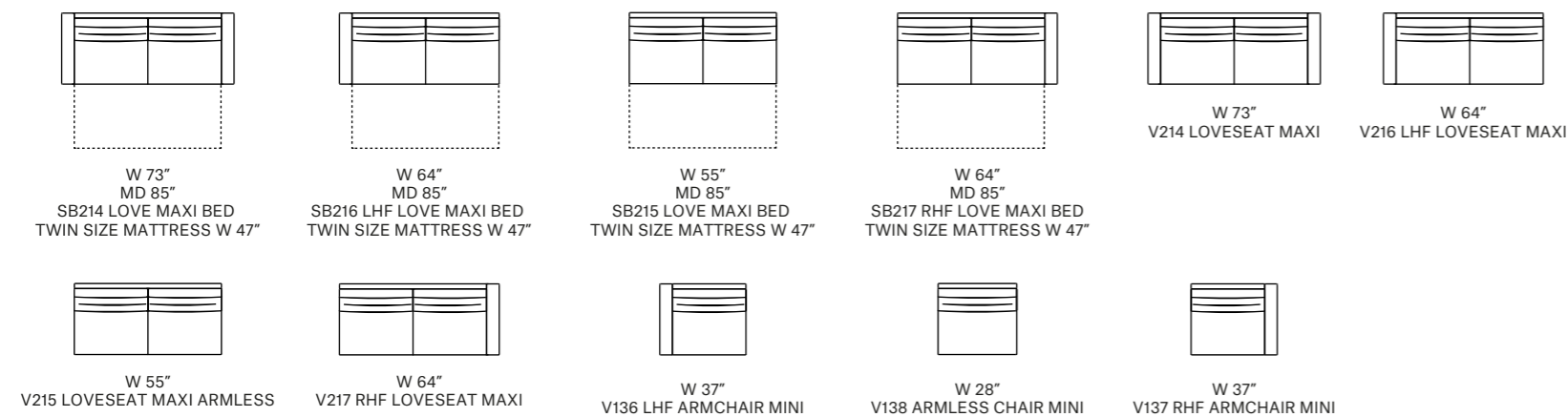

JOLLY (can be combined with all the version group)

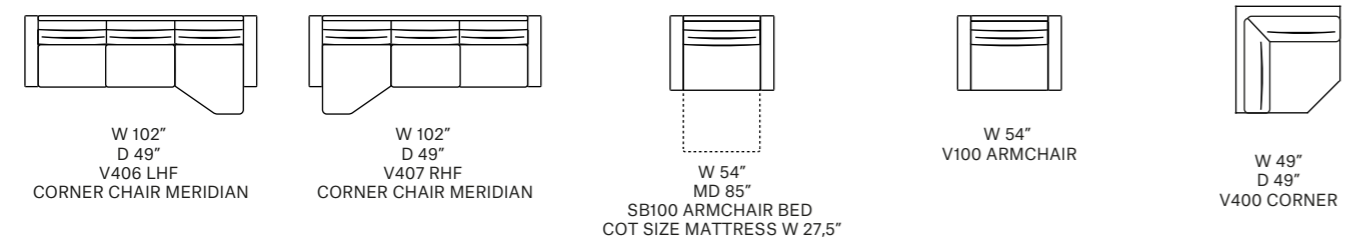

Romina

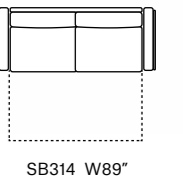

Technical Description

thick stitch: Available as an option

structure: Synchronized and orthopedic metal bed mechanism. Bed area made with beech wood slats 6,3"wide. Reinforced elastic webbing on the seating area.

mattress h 6,3" : Waterlily viscoelastic high density and high resilience foam, covered with a special polyester fiber fire retardant. External quilted layer made in cotton fabric. The Mattress is 100% recyclable, antibacterial, breathable.

back suspension: Reinforced elastic webbing

seat cushions: High density ecologic open-cell polyurethane foam and memory foam, covered with a layer of dacron wadding

back cushions: High density ecologic open-cell polyurethane foam, covered with a layer of dacron wadding

removability: Seat and Back cushion removability is not available for the sofa bed version. Removability is only available on version without bed

foot option: Walnut Wooden Foot

Foot Finishing Option



Thin stitch standard

Thick stitch option



Foot Option :
Walnut Wooden Foot

LEATHER COLOR SHADE DIFFERENCES: The model upholstered with some Natural leather such as Maya, Moss, Carees and Sensation, could present in some area differences in color tones of about 5%. Such differences are not to be considered defect but an expression of the natural characteristic of the cowhide. The company reserves the right without prior notice to make technical sheets changes and/or materials for quality product improvement. Leather sofas are a handmade product and according to the leather covering selected there could be a measurement tolerance of about 2 inches (cm 5) on each sku.

REV. 002 DEL 28/10/2020 | Pag. 2 of 2

Vera

Vera does not look like a sofa bed and has an extremely good seating comfort as the seat is filled with the right combination of memory foam. It is built with a state-of-the-art bed mechanism which has wooden slats, then seats and backs are always attached during the opening and closing. The mattress has a 6" thickness and is made in a high-end foam called Waterlilly, which has a high density, is 100% natural, and breathable. Sleeping on this sofa bed is just like sleeping in a regular bed.



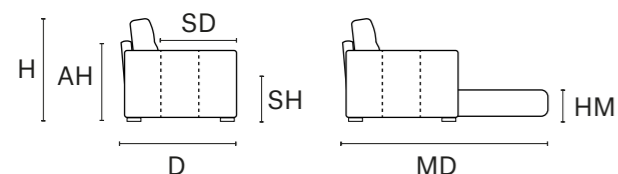

Arms and back are detachable on sofa bed version by just pulling up

D 42" H 35" AH 27" SH 19" SD 22" MD 86" HM 22"

MAXI SEAT (version of the group have the same seat width)

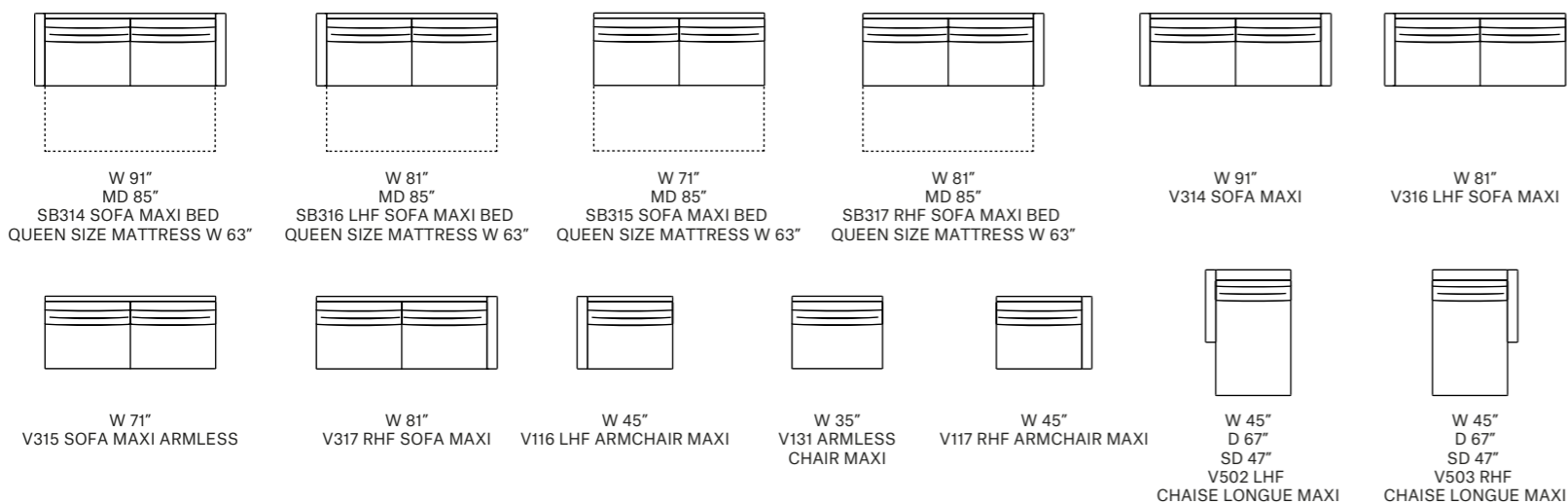

MEDIUM SEAT (version of the group have the same seat width)

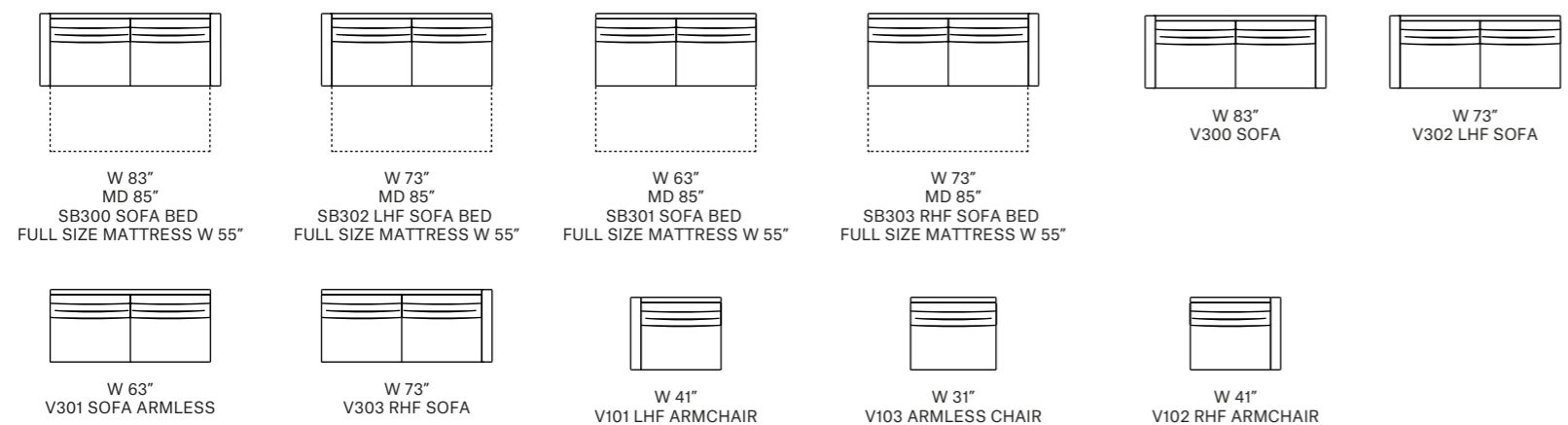

SMALL SEAT (version of the group have the same seat width)

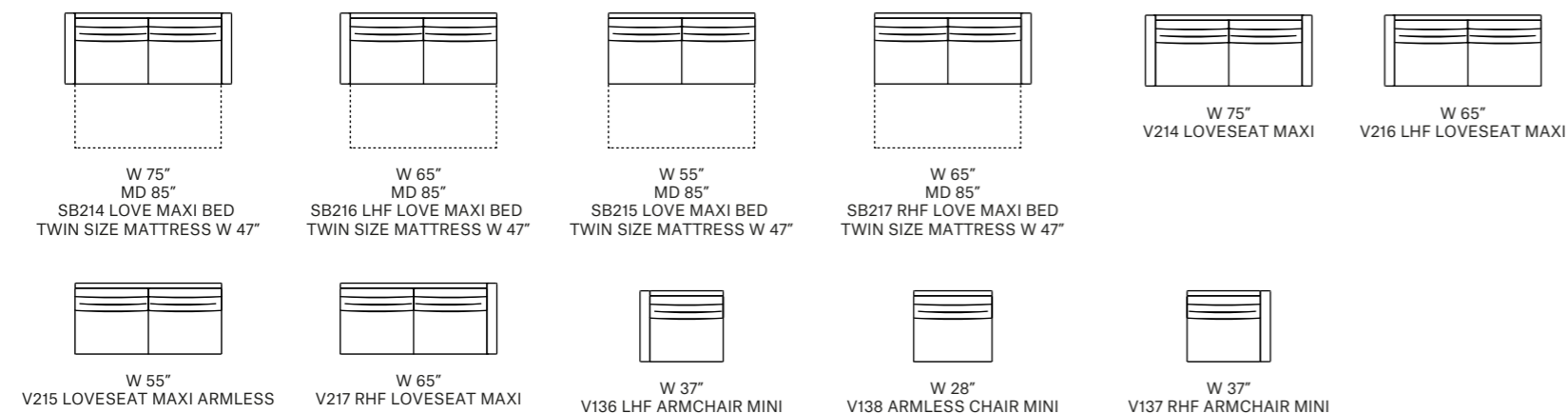

JOLLY (can be combined with all the version group)

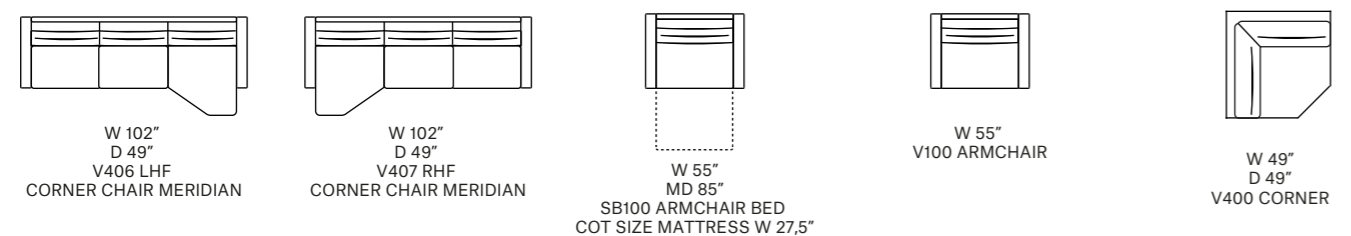

Vera

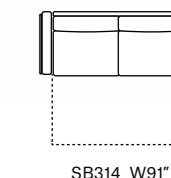

Technical Description

thick stitch: Available as an option
structure: Synchronized and orthopedic metal bed mechanism. Bed area made with beech wood slats 6,3"wide. Reinforced elastic webbing on the seating area.
mattress h 6,3" : Waterlily viscoelastic high density and high resilience foam, covered with a special polyester fiber fire retardant. External quilted layer made in cotton fabric. The Mattress is 100% recyclable, antibacterial, breathable.
back suspension: Reinforced elastic webbing
seat cushions: High density ecologic open-cell polyurethane foam and memory foam, covered with a layer of dacron wadding
back cushions: High density ecologic open-cell polyurethane foam, covered with a layer of dacron wadding
removability: Seat and Back cushion removability is not available for the sofa bed version. Removability is only available on version without bed
foot option: Walnut Wooden Foot

Foot Finishing Option



Thin stitch standard



Thick stitch option



Foot Option :
Walnut Wooden Foot

LEATHER COLOR SHADE DIFFERENCES: The model upholstered with some Natural leather such as Maya, Moss, Carees and Sensation, could present in some area differences in color tones of about 5%. Such differences are not to be considered defect but an expression of the natural characteristic of the cowhide. The company reserves the right without prior notice to make technical sheets changes and/or materials for quality product improvement. Leather sofas are a handmade product and according to the leather covering selected there could be a measurement tolerance of about 2 inches (cm 5) on each sku.
REV. 002 DEL 28/10/2020 | Pag. 2 of 2

POWER RECLINERS

An armchair is first and foremost comfort. The body finds space between the padding that embraces and welcomes it in the most ergonomic of ways. Inside, the technological core follows the natural movements of the body, allowing you to relax your legs, arms, head, and thoughts. An armchair whose design actually means beauty and functionality, an armchair that brings the Made in Bracci and Made in Italy style into the most contemporary American living room.



Pag. 288
DAVINCI



Pag. 292
LINCOLN



Pag. 290
GALILEO



Pag. 294
MEUCCI



Davinci

Davinci power recliner main features are comfort, support and design. This power recliner is equipped with a state of the art power mechanism and touchpad that individually controls footrest and backrest. The headrest also has 3 different positions and can be adjusted by hand.

Technical Description

decor stitch: Tipe "D" : available as option

thick stitch: Available as option

structure: Metal, Firwood and ecologic polyurethane foam

back cushion: High density ecologic open-cell polyurethane foam covered with a layer of dacron wadding

seat cushion: High density ecologic open-cell polyurethane foam and memory foam covered with a layer of of dacron wadding

power mechanism version:

- Individual electric or manual mechanism for footerest
- Individual electric or manual mechanism for backrest
- Manual ratchet for headrest with different positions

battery: Included lithium battery pack

pushbuttons illuminated :(only with electric mechanism)

- Green light battery is charged
- Red light battery needs to be charged
- Plug for battery charger is located in pushbutton

manual mechanism version: Push back footrest opening. Hold arms and with body push seat out and footrest will open.

Move level on side seat to adjust backrest according to position required

base series: Swivel base turns 360° for both versions

option 1: Stainless Steel Base

option 2: Stainless Steel Base Black Finish



Foot Finishing Option



Foot Option 1:
Stainless Steel Base



Foot Option 2:
Stainless Steel Base Black Finish

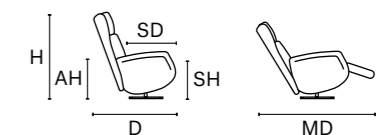

D 37" MD 67" H 43" AH 26" SH 20" SD 21"

Thin stitch standard



Thick stitch option



Decor Stich Option



Decor stitch:
Tipe D

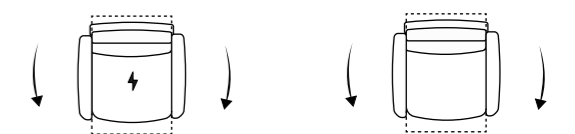

W 31"
V144 ARMCHAIR SWIVEL ELECTRIC
RECLINER BACK AND FOOT

W 31"
V151 ARMCHAIR SWIVEL MANUAL
RECLINER BACK AND FOOT



Galileo

Galileo power recliner main features are comfort, support and design. This power recliner is equipped with a state of the art power mechanism and touchpad that individually controls footrest and backrest. The headrest also has 3 different positions and can be adjusted by hand.

Technical Description

thick stitch: Available as option

structure: Metal, Firwood and ecologic polyurethane foam

back cushion: High density ecologic open-cell polyurethane foam covered with a layer of dacron wadding

seat cushion: High density ecologic open-cell polyurethane foam and memory foam covered with a layer of of dacron wadding

power mechanism version:

- Individual electric or manual mechanism for footrest
- Individual electric or manual mechanism for backrest
- Manual ratchet for headrest with different positions

battery: Included lithium battery pack

pushbuttons illuminated : (only with electric mechanism)

- Green light battery is charged
- Red light battery needs to be charged
- Plug for battery charger is located in pushbutton

manual mechanism version: Push back footrest opening. Hold arms and with body push seat out and footrest will open. Move level on side seat to adjust backrest according to position required

base series: Swivel base turns 360° for both versions

option 1: Stainless Steel Base

option 2: Stainless Steel Base Black Finish



Foot Finishing Option



Foot Option 1:
Stainless Steel Base



Foot Option 2:
Stainless Steel Base Black Finish

Thin stitch standard



Thick stitch option

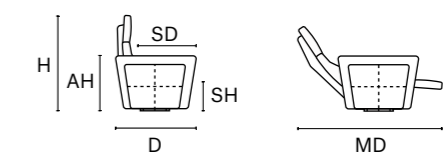

D 39" MD 66" H 44" AH 28" SH 22" SD 22"

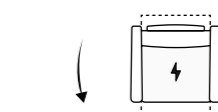

W 33"
V144 ARMCHAIR SWIVEL ELECTRIC
RECLINER BACK AND FOOT

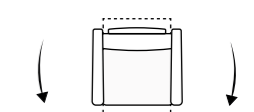

W 33"
V151 ARMCHAIR SWIVEL MANUAL
RECLINER BACK AND FOOT



Lincoln

Lincoln power recliner main features are comfort, support and design. This power recliner is equipped with a state of the art power mechanism and touchpad that individually controls footrest and backrest. The headrest also has 3 different positions and can be adjusted by hand.

Technical Description

thick stitch: Available as option

structure: Metal, Firwood and ecologic polyurethane foam

back cushion: High density ecologic open-cell polyurethane foam covered with a layer of dacron wadding

seat cushion: High density ecologic open-cell polyurethane foam and memory foam covered with a layer of dacron wadding

power mechanism version:

- Individual electric or manual mechanism for footrest
- Individual electric or manual mechanism for backrest
- Manual ratchet for headrest with different positions

battery: Included lithium battery pack

pushbuttons illuminated: (only with electric mechanism)

- Green light battery is charged
- Red light battery needs to be charged
- Plug for battery charger is located in pushbutton

manual mechanism version: Push back footrest opening. Hold arms and with body push seat out and footrest will open. Move level on side seat to adjust backrest according to position required

base series: Swivel base turns 360° for both versions

option 1: Stainless Steel Base

option 2: Stainless Steel Base Black Finish



Foot Finishing Option

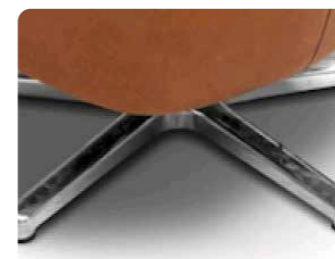

Foot Option 1:
Stainless Steel Base



Foot Option 2:
Stainless Steel Base Black Finish

Thin stitch standard



Thick stitch option

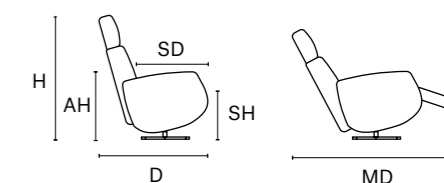

D 37" MD 67" H 43" AH 25" SH 19" SD 21"

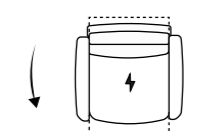

W 32"
V144 ARMCHAIR SWIVEL
ELECTRIC RECLINER
BACK AND FOOT

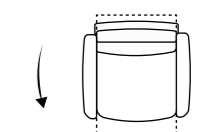

W 32"
V151 ARMCHAIR SWIVEL
MANUAL RECLINER
BACK AND FOOT



Meucci

Meucci power recliner main features are comfort, support and design. This power recliner is equipped with a state of the art power mechanism and touchpad that individually controls footrest and backrest. The headrest also has 3 different positions and can be adjusted by hand.

Technical Description

thick stitch: Available as option

structure: Metal, Firwood and ecologic polyurethane foam

back cushion: High density ecologic open-cell polyurethane foam covered with a layer of dacron wadding

seat cushion: High density ecologic open-cell polyurethane foam and memory foam covered with a layer of dacron wadding

power mechanism version:

- Individual electric or manual mechanism for footrest
- Individual electric or manual mechanism for backrest
- Manual ratchet for headrest with different positions

battery: Included lithium battery pack

pushbuttons illuminated: (only with electric mechanism)

- Green light battery is charged
- Red light battery needs to be charged
- Plug for battery charger is located in pushbutton

base series: Swivel base turns 360° for both versions

option 1: Stainless Steel Base

option 2: Stainless Steel Base Black Finish



Foot Finishing Option



Foot Option 1:
Stainless Steel Base



Foot Option 2:
Stainless Steel Base Black Finish

Thin stitch standard



Thick stitch option

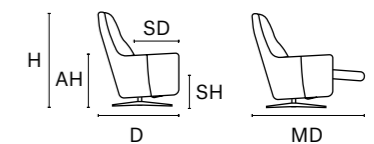

D 35" MD 63" H 44" AH 26" SH 19" SD 20"

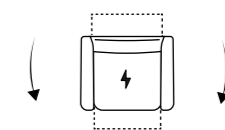

W 33"
V144 ARMCHAIR SWIVEL ELECTRIC
RECLINER BACK AND FOOT

OCCASIONAL CHAIRS

Complete the living area with extraordinary simplicity: all it takes is an occasional chair. Modern, elegant, classic. Featuring harmonious or geometric lines. Cozy or gritty, however yours is, it will be a stylistic choice that adds character to the room and always gives utmost comfort and support.



Pag. 298
BARRY



Pag. 301
FREEDOM



Pag. 304
PRINCE



Pag. 299
BUBBLE



Pag. 302
MARS



Pag. 305
SATURN



Pag. 300
FIRENZE



Pag. 303
MERCURY



Pag. 306
VENUS



Barry

Barry is modern classic design chair with a great seating comfort which would look great in any interior décor.

Technical Description

- thick stitch:** Available as option
- structure:** Hardwood frame for extra strenght
- seat/back cushion:** High density ecologic open-cell polyurethane foam covered with a layer of dacron wadding
- removability:** Not available
- foot/base option** – version v140 armchair swivel – with swivel base turns 360°
– version v100 armchair with not visible foot

Thin stitch standard



Thick stitch option

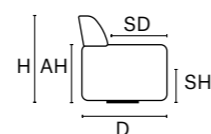

D 36" H 35" AH 26" SH 18" SD 21

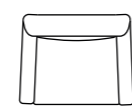

W 35"
V 100 ARMCHAIR

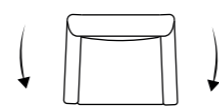

W 35"
V 140 ARMCHAIR SWIVEL



Bubble

Bubble is a stylish modern club chair with a great seating comfort which would look great in any interior décor.

Technical Description

- decor stitch:** Type "E" Available as option
- thick stitch:** Available as option
- structure:** Hardwood frame for extra strength
- seat/back cushion:** High density ecologic open-cell polyurethane foam covered with a layer of dacron wadding
- removability:** Not available
- mechanisms:** Not Available
- foot base options:** – Version V140 Armchair Swivel – with swivel base turns 360°
– Version V100 Armchair with not visible foot

Thin stitch standard



Thick stitch option



Decor Stich Option



Decor stitch:
Type E

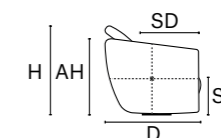

D 35" H 35" AH 27" SH 18" SD 20"

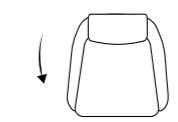

W 33"
V140 ARMCHAIR SWIVEL



W 33"
V100 ARMCHAIR

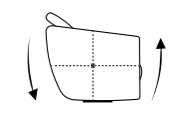

W 33"
H 37"
V153 ARMCHAIR SWIVEL
AND GLIDER

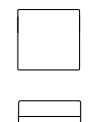

W 24"
D 24"
V600 OTTOMAN



Firenze

Firenze is a model with a sophisticated design and great seating comfort which would look great in any room and furnishing style.

Technical Description

- thick stitch:** Available as option
- structure:** hardwood frame for extra strenght
- seat/back suspension:** Reinforced elastic webbing
- seat/back cushions:** High density ecologic open-cell polyurethane foam covered with a layer of dacron wadding
- removability:** Not available
- detachability:** Not available
- foot/base option** – Version V140 Armchair Swivel – with Swivel base turns 360°
– Version V100 Armchair with not visible foot

Thin stitch standard



Thick stitch option

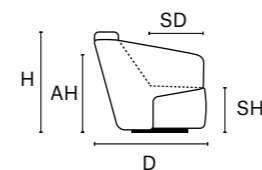

D 38" H 32" AH 26" SH 17" SD 23

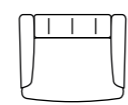

W 32"
V100 ARMCHAIR

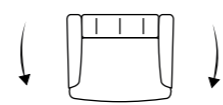

W 32"
V140 ARMCHAIR SWIVEL



Freedom

Freedom is a chair with a sophisticated design which would look great in any room and furnishing style.

Technical Description

- thick stitch:** available as option
- structure:** hardwood frame for extra strenght
- seat/back cushion:** High density ecologic open-cell polyurethane foam covered with a layer of dacron wadding
- removability:** Not available
- foot/base option** – Version V140 Armchair Swivel – with Swivel base turns 360°
– Version V100 Armchair with not visible foot

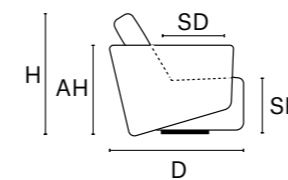

D 36" H 35" AH 26" SH 18" SD 21"

Thin stitch standard



Thick stitch option



MAXI SEAT (version of the group have the same seat width)

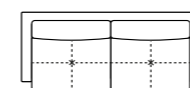

W 94"
V314 SOFA MAXI

STANDARD



W 80"
V300 SOFA

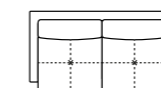

W 55"
V200 LOVESEAT

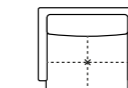

W 31"
V100 ARMCHAIR

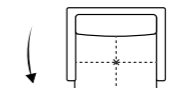

W 31"
V140 ARMCHAIR SWIVEL



W 31"
H 33"
V153 ARMCHAIR SWIVEL AND GLIDER

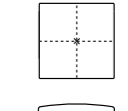

W 26"
H 18"
V600 OTTOMAN



Mars

Mars is a swivel chair with a contemporary design characterized by special sartorial details on the side arms and tufted seat and back.

Technical Description

- thick stitch** : not available
- structure**: hardwood frame for extra strenght
- seat/back suspension** : reinforced elastic webbing
- seat/back cushions** :High density ecologic open-cell polyurethane foam covered with a layer of dacron wadding
- removability**: Not available
- detachability**: not available
- base option 1 for v140** : Stainless Steel Base Finish
- base option 2 for v140** : Stainless Steel Base Bronze Finish
- foot option 1 for v100** : Stainless Steel Finish
- foot option 2 for v100** : Stainless Steel Bronze Finish

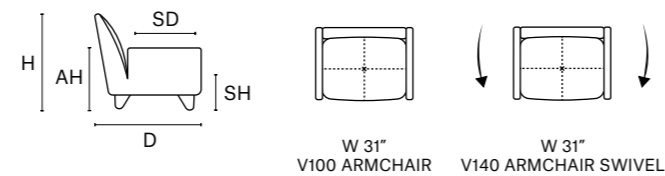

D 35" H 36" AH 24" SH 18" SD 23"

Thin stitch standard



Foot Finishing Option



Foot Option 1:
Stainless Steel Base Finish



Foot Option 2:
Stainless Steel Base Bronze Finish



Foot Option 3:
Stainless Steel Finish



Foot Option 4:
Stainless Steel Bronze Finish



Mercury

Mercury is a generic swivel chair with a sophisticated design that would look great in any room and furnishing style.

Technical Description

- thick stitch**: Available
- structure**: Hardwood frame for extra strenght
- seat/back suspension**: Reinforced elastic webbing
- seat/back cushions**: High density ecologic open cell polyurethane foam and memory foam covered with a layer of dacron wadding
- removability**: Not available
- detachability**: not available
- base option 1 for v140**: Stainless Steel Base Finish
- base option 2 for v140**: Stainless Steel Base Bronze Finish
- foot option 3 for v100**: Stainless Steel Finish
- foot option 4 for v100**: Stainless Steel Bronze Finish

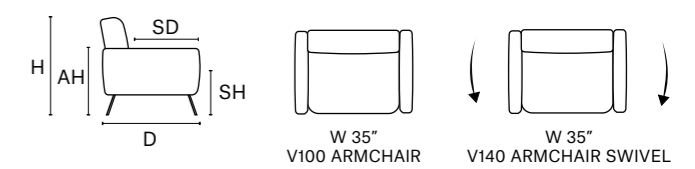

D 39" H 35" AH 24" SH 17" S D 22"

Thin stitch standard



Thick stitch option



Foot Finishing Option



Foot Option 1:
Stainless Steel Base Finish

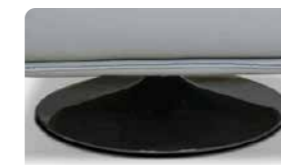

Foot Option 2:
Stainless Steel Base Bronze Finish



Foot Option 3:
Stainless Steel Finish



Foot Option 4:
Stainless Steel Bronze Finish



Prince

Prince swivel chair has sophisticated design which would look great in any room and furnishing style.

Technical Description

decor stitch: type "B": Available as option

thick stitch: Available as option

covering: Full leather

structure: Hardwood frame for extra strength

seat /back cushion: High density ecologic open-cell polyurethane foam covered with a layer of dacron wadding

removability: Not available

mechanisms: N.A.

foot base options: – Version V140 Armchair Swivel – with swivel base turns 360°
– Version V100 Armchair with not visible foot

Thin stitch standard



Thick stitch option



Decor Stich Option



Decor stitch:
Tipe B

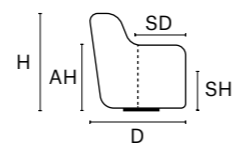

D 36" H 36" AH 25" SH 17"

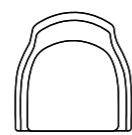

W 32"
V100 ARMCHAIR

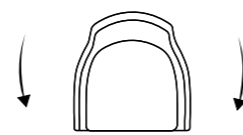

W 32"
V140 ARMCHAIR SWIVEL



Saturn

Saturn is a sophisticated modern lounge chair with a metal frame available in different finishes. This chair is the result of a perfect balance between design and seating comfort.

Technical Description

thick stitch: Available as option

structure: hardwood frame for extra strength

seat/back suspension: Reinforced elastic webbing

seat/back cushions: High density ecologic open-cell polyurethane foam covered with a layer of dacron wadding

removability: Not available

detachability: Not Available

foot option# 1: Stainless Steel Arm Sled

foot option# 2: Stainless steel arm sled bronze finish

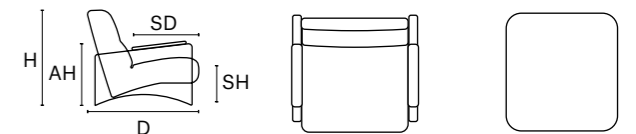

W 30"
D 26"
V100 ARMCHAIR

W 26"
D 26"
SH 17"
V600 OTTOMAN

Foot Finishing Option



Foot Option 1:
Stainless Steel Arm Sled



Foot Option 2:
Stainless Steel Bronze Finish Arm Sled

D 40" H 34" AH 23" SH 17" SD 22"

Thin stitch standard



Thick stitch option





Venus

Venus is a stylish modern swivel chair and stationary chair with a great seating comfort that would look great in any interior décor. The artisan workmanship on seats and backs give this model a really sartorial unique look.

Technical Description

thick stitch: Not Available

pipng as standard: Available without piping on request

structure: Hardwood frame for extra strength

seat/ back suspension: Reinforced elastic webbing

seat/back cushions: High density ecologic open-cell polyurethane foam and memory foam covered with a layer of dacron wadding

removability: Not available

detachability: Not Available

foot option # 1: Stainless Steel Base Finish (Turns 360°)

foot option # 2: Stainless Steel Base Bronze Finish (Turns 360°)

foot option #3: Stainless Steel Finish

foot option #4: Stainless Steel Bronze Finish



D 32" H 34" AH 26" SH 17" SD 21"

Thin stitch standard



Foot Option 1:
Stainless Steel Base Finish



Foot Option 2:
Stainless Steel Base Bronze Finish



Foot Option 3:
Stainless Steel Finish



Foot Option 4:
Stainless Steel Bronze Finish

PILLOWS

Softness at first glance. Versatility. Exclusive coverings. Every pillow offers extra relaxation, beauty, personalized comfort. You simply need to choose yours.

LONDON



THICK STITCH: AVAILABLE
 V628 LONDON SMALL - 18"X 18"
 V629 LONDON MEDIUM - 20"X 20"
 V630 LONDON LARGE - 24"X 24"

PARIS

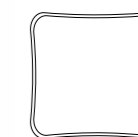

THICK STITCH: NOT AVAILABLE
 V628 PARIS SMALL - 18"X 18"
 V629 PARIS MEDIUM - 20"X 20"
 V630 PARIS LARGE - 24"X 24"

GENERIC PILLOW FRONT

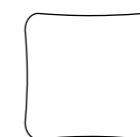

THICK STITCH: AVAILABLE
 V629 GENERIC PILLOW MEDIUM - 20"X 20"
 V630 GENERIC PILLOW LARGE - 24"X 24"

GENERIC PILLOW BACK

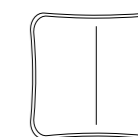

THICK STITCH: AVAILABLE
 V629 GENERIC PILLOW MEDIUM - 20"X 20"
 V630 GENERIC PILLOW LARGE - 24"X 24"

Thanks to:

A.D. | Giovanni pesce studiodesign

BRACCI
MADE IN ITALY

BRACCI LLC
P.O. BOX 16044
High Point, N.C. 27261

Contact person: Mr. Mauro Bracciale
Mail: info@braccisofas.com

Phone:
US PHONE 336 847 3232

BRACCI LLC reserves the rights at all time to apply modifications for the functional or qualitative improvement of its products. Texts and drawings present in this brochure have a divulgative purpose.

All right reserved © 2022 **BRACCI SOFAS**